

REO

REOVIB
Vibratory conveyor technology



Useful facts about REOVIB vibratory conveyor technology

Vibratory technology is a specialist field of industrial conveyor systems. It is used for conveying a variety of materials in assembly, packaging and filling machines. Areas of application are extremely wide and varied, for example in industrial assembly automation, pharmaceutical packaging systems, industrial conveyor technology and in food processing and packaging.

Conveyor & assembly automation

Standalone control units for direct control of conveyor systems

- REOVIB SMART Series
- REOVIB RTS Series
- REOVIB MTS Series
- REOVIB MFS Series
- REOVIB AC magnets

Filling & packagin technology

Equipment for installation in control cabinets, field bus interface options, installation solutions

- REOVIB SMART Series
- REOVIB RTS Series
- REOVIB MTS Series
- REOVIB MFS Series
- REOVIB AC magnets

Test & service equipment

- Measuring equipment for service
- Workshops equipment for conveyor manufacture and quality assurance
- Acceleration sensors
- Connecting plugs

Complete solutions for controlling vibratory conveyor technology, from control devices to AC magnets and on to special metrology equipment. The unique combination of REO's electronic and inductive knowledge and experience, means that vibration technology is our focus, whether for bowl, linear or hopper conveyors – REO can supply the appropriate solution.

Conveyting & Grading

Great handling capacity Mains voltages up to 500V Output currents up to 45 A Solutions for installation in control cabinets or in standalone housings

- REOVIB SMART Series
- REOVIB RTS Series
- REOVIB MTS Series
- REOVIB MFS Series
- REOVIB AC magnets

Hoppers & Bilk Storage

Motor starters, motor control equipment for motor driven hoppers and inclined conveyors

Measurement & monitoring

- Vibration amplitude sensors
- Acceleration monitors

Service



Training

REO AG is your holistic partner in the area of inductive, resistive and electronic components and full solutions. A wide range of training services are also a key aspect of this partnership. These simplify commissioning of new devices and systems and guarantee hassle-free use during the whole product life cycle. [Training sessions at your site or on the premises of REO AG](#) form the basis for this. Our internal training managers instruct your employees in the technology and provide valuable tips on the correct and safe use of REO components. Our training sessions are available for both standard solutions and high-quality individualised components. Multimedia and easy to understand content supplement the training and also permit international deployment.



Guarantee

Winning quality – extra peace of mind, thanks to the expanded REO manufacturer's guarantee.

We believe in the quality of our own products and are confident of the durability of all components used, which is why we have extended the legal [guarantee from one to two years](#).



Safety

We offer you devices with the highest possible operational safety. Should any unwanted events occur with any of our products, your professional emergency responder will be available to help you over the telephone free of charge. If the situation or query cannot be resolved over the telephone, you have the opportunity to have the defective device sent back after consultation.



Repairs

After telephone consultation, and after the defective product has been received, we can even offer you [express repairs](#) if possible. This minimises downtime in the event of a fault and guarantees a swift exchange.



Hotline

Our REO sales specialists look forward to giving you a helping hand. Contact your REO contact partner or call our hotline to receive further information about our services and the REO portfolio.

Catalogue overview

REOVIB Vibratory conveyor technology

REOVIB P. 5-32

Useful facts

REOVIB Smart System

REOVIB SMART

New - REOVIB SMART-MIC

REOVIB RTS System

REOVIB RTS

REOVIB MTS

REOVIB MFS 158, 168

REOVIB MFS 268

NEW REOVIB MFS 368

REOVIB MFS 268 HP

REOVIB Measuring equipment

REOVIB Acceleration sensors

REOVIB Connection accessories

AC-Magnets P. 33-51

Useful facts

REOVIB WI 111

REOVIB WI 121

REOVIB WI 421

REOVIB WI 721

REOVIB WI 211

REOVIB WE 131

Service

General informations

The REO logo is displayed in white, stylized, outlined letters on a solid blue rectangular background. The background of the entire page is a close-up, slightly blurred photograph of a grey electronic device with several control panels, each featuring a set of white directional and function buttons (up, down, left, right, P, F) and two larger colored buttons (red with '0' and green with '|').

REO

REOVIB

www.reo.de

REOVIB

Control devices, Measuring equipment and Accessories

Useful facts	P. 7
REOVIB Smart System	P. 8-9
REOVIB SMART	P. 10
New - REOVIB SMART-MIC	P. 11
REOVIB RTS System	P. 12-13
REOVIB RTS	P. 14-15
REOVIB MTS	P. 16-17
REOVIB MFS 158, 168	P. 18-19
REOVIB MFS 268	P. 20-21
NEW REOVIB MFS 368	P. 22-23
REOVIB MFS 268 HP	P. 24-25
REOVIB Measuring equipment	P. 26-27
REOVIB Acceleration sensors	P. 28-29
REOVIB Connection accessories	P. 30

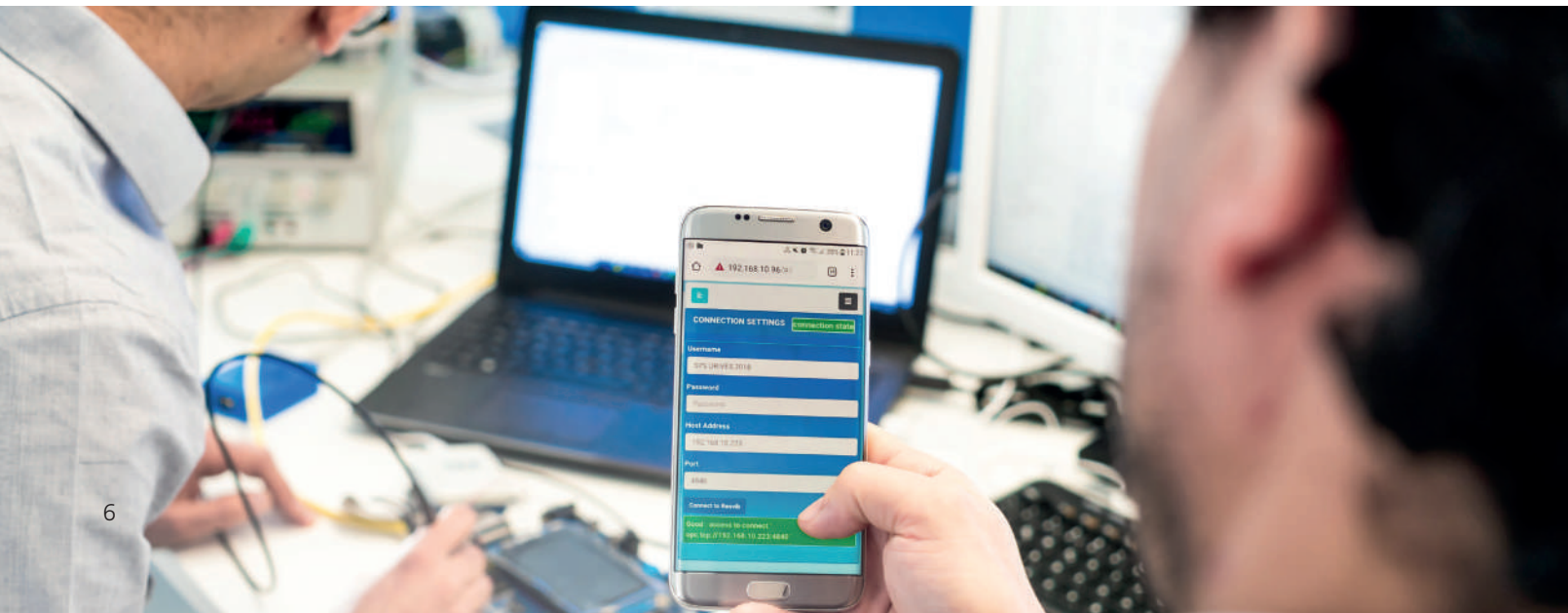

Useful facts about REOVIB

Every vibratory conveyor requires a control unit to optimize process performance. The REOVIB range includes various control products to provide all the control characteristics required of a vibratory conveyor for the flow of conveyed product. These product lines include a large number of control units, starting with simple control systems using triacs or thyristors in phase-angle operation to provide a variable voltage to the magnets, to frequency converters that can generate any desired operating frequency and amplitude for vibratory conveyors.

There are many ways for us to provide solutions, from providing printed circuit assemblies for integration into a client's own housing, through to equipment for installation in control cabinets for DIN rail mounting and on to standalone designs with ingress protection from IP54 to IP65. Individual devices can be linked via control inputs and outputs into systems that operate complete feeder stations. Connections with higher-level control systems can be implemented via analogue signals or through fieldbus couplings such as Profibus, CAN bus, EtherCAT or DeviceNet. Many versions are also available with UL/CSA certification.

IIoT-Ready

Investment in the future

Industry 4.0 is the strategy for comprehensive digitalisation of industrial production. Digital technologies and processes are paving the way for completely new approaches for production and services. With ongoing changes in industry, production and communication requirements are increasing in relation to scalability and interoperability.

With REO, you have a competent partner at your side to master the challenges of Industry 4.0. REO will equip its devices to be IIoT-ready for this and has launched hardware and software solutions developed in house.

With the REONET DL (Devices Link) interface, you can access devices via a conventional network infrastructure. Using OPC-UA enables REONET DL to participate in the world's largest ecosystem based on common standards.

With the REONET CT (Configuration Tool) software, you can also simplify device configuration. Configurations for devices can be created and distributed via a web interface. The automatic procedure ensures that no parameters are missed and devices are supplied as intended. The software can also save configurations so that they can be adapted or restored at any time.

REOVIB Smart System

REOVIB SMART SYSTEM basic module

In open design for assembly on a DIN rail with an output channel of max. 6A with fill level/overflow control. The basic module has a supply for expansion modules, so further output modules up to a total current of 10A can be connected.

REOVIB SMART SYSTEM expansion module

In open design for DIN rail mounting. An expansion module has an output channel max. 6A with fill level/overflow control and can be set up together with the basic module and several expansion modules.

REOVIB SMART SYSTEM MINI basic module

In open design for DIN rail mounting with an output channel of max. 1A. The basic module has a supply for expansion modules, so further output modules can be connected in series up to a total current of 10A.

REOVIB SMART SYSTEM MINI expansion module

in open design for DIN rail mounting. An expansion module has one output channel max. 1A and can be set up together with the basic module and several expansion modules.

REOVIB SMART SINGLE

In open design for assembly on a DIN rail with an output channel of max. 6A.

Vorteile

- Cost-effective phase-angle control systems with vital functionality
- Can be used as a standalone device or in modular design for control of a complete feed system
- Output current up to 6A
- DIN rail mounting
- Versions available with fill level/overflow control

REOVIB SMART SINGLE IP00



REOVIB SMART SYSTEM IP00 basic module



REOVIB SMART SYSTEM IP00 expansion module



REOVIB SMART SYSTEM IP00 MINI basic module



REOVIB SMART SYSTEM MINI IP00 expansion module



REOVIB SMART SYSTEM MINI for DIN rail assembly
Example here: 1 basic module + 2 expansion modules for a 3-channel control system



Technical data

REOVIB Phase-angle control systems SMART System					
Type	SMART Single	SMART Basic module	SMART Expansion module	SMART mini Basic module	SMART mini Expansion module
Mains input	110 / 230 V switchable	110 / 230 V switchable	via SMART Basic module	110 / 230 V switchable	über SMART mini Basic module
Mains frequency	50 / 60 Hz +/- 3 Hz	50 / 60 Hz +/- 3 Hz	via SMART Basic module	50 / 60 Hz +/- 3 Hz	via SMART MINI Basic module
Output voltage	20...100 V / 40...210 V	20...100 V / 40...210 V	20...100 V / 40...210 V	20...100 V / 40...210 V	20...100 V / 40...210 V
Output current	max. 6 A	max. 6 A	max. 6 A	max. 1 A	max. 1 A
Vibration frequency	50 / 100 Hz (60 / 120 Hz)	50 / 100 Hz (60 / 120 Hz)	50 / 100 Hz (60 / 120 Hz)	50 / 100 Hz (60 / 120 Hz)	50 / 100 Hz (60 / 120 Hz)
Setpoint value	Poti, 0...10 V, 0(4) ... 20 mA	Poti, 0...10 V, 0(4) ... 20 mA	Poti, 0...10 V, 0(4) ... 20 mA	Poti, 0...10 V, 0(4) ... 20 mA	Poti, 0...10 V, 0(4) ... 20 mA
Ext. Enable	24 V DC, Switch	24 V DC, Switch	24 V DC, Switch	24 V DC, Switch	24 V DC, Switch
U_{min} / U_{max}	Internal potentiometer	Internal potentiometer	Internal potentiometer	Internal potentiometer	Internal potentiometer
Soft start	Fixed	Fixed	Fixed	Fixed	Fixed
Max. Output current from all outputs	-	10 A	-	10 A	-
Fill level/overflow control	-	✓	✓	-	-
Conformity	CE, RoHS	CE, RoHS	CE, RoHS	CE, RoHS	CE, RoHS
Protection class	IPO0	IPO0	IPO0	IPO0	IPO0



Our experts suggest the following ACMagnets: WI 111, WI 121, WI 421 (6000 1/min, 3000 1/min), WI 621 (6000 1/min, 3000 1/min), WI 211, WE 131

Typical applications: Weighing systems, multiple-head weighing wagon, conveyor & assembly automation, sorting systems

REOVIB SMART

The **REOVIB SMART** series contains phase angle control devices for use in vibratory conveyor applications. The devices provide the most important functions for use in vibratory conveyor engineering and they therefore represent a cost-efficient option for controlling vibratory conveyors, and all of this comes in a high-quality design.

The devices are available in various protection classes - as a module for mounting in a switch cabinet IP20 or as a housing design in IP54 for mounting directly on the vibrating machine. The housing designs with protection class IP54 are available in different versions:

- Input cable/output cable
- Input cable/output socket

- Complete cable connection solution for mains, output and control connections. In addition to the functions and advantages of the REOVIB SMART series, the control device has compensation for mains voltage fluctuations with constant vibration amplitude - and an adjustable soft starting ramp time.

REOVIB SMART RTS 15 devices sind verfügbar are available in an IP 54 housing with output currents up to 15 A and are listed by UL.

Advantages SMART

- Cost-effective phase-angle control systems with vital functionality
- IP54 design for standalone application or IP20 design for installation in a control cabinet
- Versions available with UL approval (SMART RTS 15)
- Output current up to 15 A

REOVIB SMART IP20

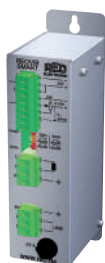

REOVIB SMART IP54



REOVIB SMART RTS 15 IP54



**UL
OPTIONAL**

Technical data

SMART		
	SMART	SMART RTS 15
Mains input	110 / 230 V switchable	110 / 230 V switchable
Mains frequency	50 / 60 Hz +/- 3 Hz	50 / 60 Hz +/- 3 Hz
Output voltage	20...100 V / 40...210 V	20...100 V / 40...210 V
Output current	max. 6 A	max. 15 A
Vibration frequency 50Hz	50 / 100 Hz	50 / 100 Hz
Vibration frequency 60Hz	60 / 120 Hz	60 / 120 Hz
Setpoint value	Poti, 0...10 V, 0...20 mA	Poti, 0...10 V, 0...20 mA
Ext. Enable	24 V DC, Switch	24 V DC, Switch
Setting U_{min} / U_{max}	Internal potentiometer	Internal potentiometer
Soft start	Fixed	Fixed
Mains voltage compensation	-	-
Conformity	CE, RoHS	UL, CE, RoHS
Protection class	IP20 / IP54	IP54
Ambient temperature	0...45 °C	0...45 °C



Smart RTS 15 Optional UL-certified

Our experts suggest the following ACMagnets: WI 111, WI 121, WI 421 (6000 1/min, 3000 1/min), WI 621 (6000 1/min, 3000 1/min), WI 211, WE 131

Typical applications: Conveyor & assembly automation, sorting systems

NEW - REOVIB SMART-MIC

The newly installed LED display means that precise values can be set to be the same every time, in contrast to the previous model. More precise settings are achieved and the traceability of inputs is simplified.

Combining Industry 4.0 and IoT-ready functionality means that the REOVIB SMART-MIC already comes with the possibilities of the communication technology of the future.

As for previous devices, REOVIB SMART-MIC series devices are also available in various protection classes - as a module for mounting in a switch cabinet IP20 or as a housing design in IP54 for mounting directly on the vibrating machine. The housing designs with protection class IP54 are available in different versions:

- Input cable/output cable
- Input cable/output socket

- Completely pluggable with input plug and sensor connector. In addition to the functions and advantages of the REOVIB SMART series, the controller offers mains voltage compensation for constant amplitude and an adjustable soft start ramp time.

Advantages SMART-MIC

- LED display
- Mains voltage compensation
- IP54-Version for mounting directly on the vibrating machine or IP20-Version as a module for mounting in a switch cabinet
- Output current up to 6 A



Technical data

SMART-MIC	
Mains input	110V/230 V switchable
Mains frequency	50 / 60 Hz +/- 3 Hz
Output voltage	20...100 V / 40 ... 210 V
Output current	max. 6A
Vibration frequency 50Hz	50 Hz / 100 Hz
Vibration frequency 60Hz	60 Hz / 120 Hz
Setpoint value	LED-Display, 0...10 V, 0 (4)...20 mA*
Ext. Enable	24 V DC, Switch
Setting U_{min} / U_{max}	LED-Display (IP54) / potentiometer (IP20)
Soft start	adjustable 0...60 Sek.
Mains voltage compensation	✓
Conformity	CE, RoHS
Protection class	IP20, IP54
Ambient temperature	0...40 °C

* Optional for IP54



Our experts suggest the following AC-Magnets: WI 111, WI 121, WI 421 (6000 1/min, 3000 1/min), WI 621 (6000 1/min, 3000 1/min), WI 211, WE 131

Typical applications: Conveyor & assembly automation, sorting systems

REOVIB RTS System

RTS SYSTEM basic module

In open type of construction for assembly on a DIN rail with an output channel of max. 6A with fill level/overflow control and mains voltage compensation. The basic module has a supply for the expansion modules, so further output modules up to a total current of 10A can be connected.

RTS SYSTEM expansion module

In open design for assembly on a DIN rail. The expansion module has an output channel max. 6A with fill level/overflow control and mains voltage compensation and can be set up together with the basic module and several expansion modules.

REOVIB RTS SINGLE

In open design for assembly on a DIN rail with an output channel of max. 6A, fill level/overflow control and mains voltage compensation.

Advantages

- Cost-effective phase-angle control systems with protection class IP00 for installation in a control cabinet
- Can be used as a standalone device or in a modular design for several outputs
- Output current up to 6A
- Fill level/overflow control
- Mains voltage compensation with constant vibration amplitude
- Adjustable soft start ramp time

REOVIB RTS Single IP00



REOVIB RTS SYSTEM IP00 basic module



REOVIB RTS SYSTEM IP00 expansion module



REOVIB RTS SYSTEM IP00 for DIN rail mounting
Example here: 1 basic module + 2 expansion modules (with filling-level control/part-overflow circuit) for a 3-channel control system



Technical data

REOVIB Phase-angle control systems RTS System			
	RTS Single	RTS Basic module	RTS Expansion module
Mains input	110 / 230 V switchable	110 / 230 V switchable	über RTS Basic module
Mains frequency	50 / 60 Hz +/- 3 Hz	50 / 60 Hz +/- 3 Hz	über RTS Basic module
Output voltage	20...100 V / 40...210 V	20...100 V / 40...210 V	20...100 V / 40...210 V
Output current	max. 6 A	max. 6 A	max. 6 A
Vibration frequency	50 / 100 Hz (60 / 120 Hz)	50 / 100 Hz (60 / 120 Hz)	50 / 100 Hz (60 / 120 Hz)
Setpoint value	Poti, 0...10 V, 0...20 mA	Poti, 0...10 V, 0...20 mA	Poti, 0...10 V, 0...20 mA
Ext. Enable	24 V DC, Switch	24 V DC, Switch	24 V DC, Switch
Setting U_{\min} / U_{\max}	Internal potentiometer	Internal potentiometer	Internal potentiometer
Soft start	Adjustable 0,2...5 Sek.	Adjustable 0,2...5 Sek.	Adjustable 0,2...5 Sek.
Max. output current from all outputs	-	10 A	-
Mains voltage compensation	✓	✓	✓
Fill level/overflow control	✓	✓	✓
Conformity	CE, RoHS	CE, RoHS	CE, RoHS
Protection class	IPO0	IPO0	IPO0



Our experts suggest the following AC-Magnets: WI 111, WI 121, WI 421 (6000 1/min, 3000 1/min), WI 621 (6000 1/min, 3000 1/min), WI 211, WE 131

Typical applications: Conveyor & assembly automation, conveyor technology, sieving technology

REOVIB RTS

Devices in the [REOVIB RTS series](#) are available as housing designs with protection class IP54 for direct assembly to the application. The maximum output current is 6 A.

Devices have mains voltage compensation with constant vibration amplitude, a relay output for status display, and an adjustable soft starting ramp time, and the [has a fill level control/overflow controller](#) (Devices with fill level control/overflow controllers include an overflow relay to link additional control devices).

The control devices are available in different versions:

- Input cable/output cable
- Input cable/output socket
- Complete cable connection solution for mains, output and control connections
(For REOVIB RTS RS6/539-559).

Advantages

- Inexpensive phase-angle control systems with extended functionality.
- IP54 design for mounting directly on the vibrating machine
- Output current up to 6 A
- Versions available with fill level/overflow control
- Mains voltage compensation with constant vibration amplitude
- Adjustable soft starting ramp time

REOVIB RTS R6/539 IP54



REOVIB RTS R6/539-559 IP54



Technical data

REOVIB Phase-angle control systems RTS System		
	RTS R6/539	RTS R56/539-559
Mains input	110 / 230 V switchable	110 / 230 V switchable
Mains frequency	50 / 60 Hz +/- 3 Hz	50 / 60 Hz +/- 3 Hz
Output voltage	20...100 V / 40...210 V	20...100 V / 40...210 V
Output current	max. 6 A	max. 6 A
Vibration frequency	50 / 100 Hz (60 / 120 Hz)	50 / 100 Hz (60 / 120 Hz)
Setpoint value	Poti, 0...10 V, 0...20 mA	Poti, 0...10V, 0...20 mA
Ext. Enable	24 V DC, Switch	24 V DC, Switch
Setting U_{min} / U_{max}	Internal potentiometer	interne Potentiometer
Soft start	Adjustable 0,2...5 Sek.	Adjustable 0,2...5 Sek.
Status relay	optional	✓
Mains voltage compensation	✓	✓
Fill level/overflow control	-	✓
Conformity	CE, RoHS	CE, RoHS
Protection class	IP54	IP54



Our experts suggest the following AC-Magnets: WI 111, WI 121, WI 421 (6000 1/min, 3000 1/min), WI 621 (6000 1/min, 3000 1/min), WI 211, WE 131

Typical applications: Conveyor & assembly automation, conveyor technology, sieving technology

REOVIB MTS

The REOVIB MTS series includes single-channel, two-channel and three-channel control units for vibratory conveyor drives. These are phase-angle control systems. The vibration frequency of the conveyor can be the same as or twice the frequency of the input voltage. (Other frequencies are possible depending on the type). Plug and socket connections for all inputs and outputs make rapid installation possible and facilitate the combination of several devices with each other or with external control systems. The devices use digital technology and are operated via a LED or LCD display and buttons. All settings can be made without the housing having to be opened.

REOVIB MTS 441 control devices have a target value setting for conveying speed. The REOVIB MTS 442 has two power outputs and the REOVIB MTS 443 has 3 power outputs, that can be linked according to the application requirements (e.g. bowl and linear conveyors). Also Various sensor and valve logic can be programmed.

All parameters of REOVIB MTS 441, 442 und 443 can be input via a display integrated into the faceplate. The devices can be used to link additional devices from the REOVIB MTS series. Application-specific settings can be stored and retrieved when required. The devices of REOVIB MTS 441 and 620 are available in protection class IP20.

Additionally the REOVIB MTS 441 is just as the REOVIB MTS 442 and 443 available in a standalone IP54 housing with various connection options:

- Complete cable connection solution for mains,
- output and control connections

REOVIB MTS 443-LCD has the same design as MTS 443, but with LCD display. The full-text display in various languages makes programming and adjustment easy and intuitive.

Important status indications and settings can easily be input and retrieved.

The control unit REOVIB MTS 620 is a phase-angle controller for regulating of the conveying speed of vibratory feeders. All parameters can be entered via an LED display integrated in the front panel. User specific settings can be stored and recalled. The device is available in IP20.

Advantages

REOVIB MTS 441, 442, 443

- Phase-angle control with programmable functions
Single-channel, two-channel or three-channel control for the optimal control of the complete conveyor system
- Digital setting of all parameters via LED display or multiline LCD display (MTS 443 LCD)
- In IP54 or IP20 design (MTS 441)
- Automatic mains voltage adjustment
- Material flow control
- Various sensor logic functions can be set
- Adjustable soft start
- With fill level/overflow control
- Integrated mains voltage compensation with constant vibration amplitude

REOVIB MTS 620

- LED display
- Possibility of connecting an external thermal contact for temperature monitoring of the magnets (as an option)
- Interchangeable fieldbus interface. The REOVIB MTS 620 can be configured according to your requirements

REOVIB MTS 441 IP54



REOVIB MTS 441 IP20



REOVIB MTS 442 IP54



REOVIB MTS 443 IP54 with LCD



REOVIB MTS 620



Technical data

REOVIB programmable Phase-angle control systems MTS					
	MTS 441	MTS 442	MTS 443	MTS 443 - LCD	MTS 620
Mains input	110 / 230 V Auto Detect	110 / 230 V Auto Detect	110 / 230 V Auto Detect	110 / 230 V Auto Detect	230V, 400 V, 480 V switchable
Mains frequency	50 / 60 Hz +/- 3 Hz	50 / 60 Hz +/- 3 Hz	50 / 60 Hz +/- 3 Hz	50 / 60 Hz +/- 3 Hz	50 / 60 Hz +/- 3 Hz
Output voltage	20...100 V / 40...210 V	20...100 V / 40...210 V	20...100 V / 40...210 V	20...100 V / 40...210 V	210 V, 360 V, 430 V
Output current	max. 6 A, max. 10 A (Option)	Per output max. 6 A	Per output max. 6 A	Per output max. 6 A	25 A
Number of outputs	1	2	3	3	1
Max. Output current from all outputs	-	10 A	10 A	10 A	-
Vibration frequency	50 / 100 Hz (60 / 120 Hz)	50 / 100 Hz (60 / 120 Hz)	50 / 100 Hz (60 / 120 Hz)	50 / 100 Hz (60 / 120 Hz)	50 Hz (25 Hz, 33,3 Hz, 50 Hz, 100 Hz) 60 Hz (30 Hz, 40 Hz, 60 Hz, 120 Hz)
Setpoint value	Display, Poti 0 ... 10 V, 0 (4) ... 20 mA	Display	Display	Display	LED-Display, 0 ... 10 V, 0(4) ... 20 mA
Statussignal	24 V DC	24 V DC	24 V DC	24 V DC	Relay changer 250 V, 1 A
Ext. Enable	24 V DC, Switch	24 V DC, Switch	24 V DC, Switch	24 V DC, Switch	24 V DC, Switch
Sensor supply	24 V DC	24 V DC	24 V DC	24 V DC	24 V DC (optional)
Setting U_{min} / U_{max}	Display	Display	Display	Display	Display
Soft start	Adjustable 0...5 Sek.	Adjustable 0...5 Sek.	Adjustable 0...5 Sek.	Adjustable 0...5 Sek.	Adjustable 0...60 Sek.
With fill level/overflow control	PNP, 24 V DC	Per output PNP, 24 V DC	Per output PNP, 24 V DC	Per output PNP, 24 V DC	PNP, 24 V DC (optional)
Mains voltage compensation	✓	✓	✓	✓	✓
Coarse/fine control	✓	✓	✓	✓	✓
Selectable timer function	✓	✓	✓	✓	-
Sensor time out monitor	✓	✓	✓	✓	-
Conformity	CE, RoHS	CE, RoHS	CE, RoHS	CE, RoHS	CE, RoHS
Protection class	IP20 / IP54	IP54	IP54	IP54	IP20



Our experts suggest the following AC-Magnets: WI 111, WI 121, WI 421 (6000 1/min, 3000 1/min), WI 621 (6000 1/min, 3000 1/min), WI 211, WE 131

Typical applications: Conveyor & assembly automation, conveyor technology, sieving technology, Filling & packaging technology

REOVIB MFS 158, 168

Frequency converters in the [REOVIB MFS 158](#) and [REOVIB MFS 168](#) series for vibratory conveyor technology offer the option of operating the vibratory conveyor at an optimal vibration frequency for the material - completely independently of the mains input frequency.

It is also possible with [REOVIB MFS 168](#), thanks to the system patented by REO, to determine the resonant frequency of the vibratory system automatically and to regulate the vibration amplitude accordingly. In addition, various sensor and valve logic links can be programmed.

Devices in the [REOVIB MFS 158](#) series are available with a max. output current of 4A and the Devices in the [REOVIB MFS 168](#) series are available with a max. output current of 3A, 6A and 8A. Both series are available as IP20 versions for installation in control cabinets or as IP54 standalone units.

The IP54 housings are available with various connection options:

- Input cable/output cable
- Input cable/output socket
- Complete cable connection solution for mains, output and control connections

Advantages

- Inexpensive frequency-control devices with the vital functionality
- Frequency-control device for controlling a vibratory conveyor independently of the mains input frequency
- Conveyor frequencies adjustable between 35...140 Hz
- Mains voltage compensation with constant vibration amplitude
- All settings can be made using the integrated display
- Sinusoidal output current
- Can be used on 110 V or 240 V mains, auto sensing.
- User settings can be stored
- With fill level/overflow control
- Versions available in various protection classes and with various connection options
- [REOVIB MFS 168](#): Automatic detection of the resonant frequency of the vibratory conveyor system (with additional vibration amplitude sensor) and option to regulate the vibration amplitude – Constant feed rates can be achieved independently of load or changes in the mechanical system

REOVIB MFS 158 IP54



REOVIB MFS 158 IP20



REOVIB MFS 168 IP54



REOVIB MFS 168 IP20



Sensor SW IP65

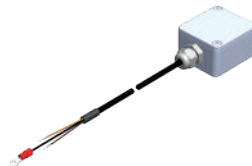

Technical data

REOVIB MFS		
	MFS 158	MFS 168
Mains input	110 / 230 V Auto Detect	110 / 230 V Auto Detect
Mains frequency	50 / 60 Hz +/- 3 Hz	50 / 60 Hz +/- 3 Hz
Output voltage	0 ... 100 V / 0 ... 205 V	0...100 V / 0...205 V
Output voltage	max. 4 A	max. 3 A / 6 A / 8 A
Vibration frequency	35...140 Hz	30...140 Hz
Setpoint value	Display, Poti, 0 ... 10 V, 0 (4) ... 20 mA	Display, Poti, 0 ... 10 V, 0 (4) ... 20 mA
Status signal	Relay changer 250 V, 1 A	Relay changer 250 V, 1 A
Ext. Enable	24 V DC, Switch	24 V DC, Switch
Sensor supply	24 V DC	24 V DC
Setting U_{\min} / U_{\max}	Display	Display
Soft start	Adjustable 0...4 Sek.	Adjustable
Fill level/overflow control	PNP, 24 V DC (Option)	PNP, 24 V DC (Option)
Coarse/fine control	✓ (Option)	✓ (Option)
Vibration amplitude regulation	-	✓ (Option)
Resonant frequency search	-	✓ (Option)
Mains voltage compensation	✓	✓
Conformity	CE, RoHS	CE, RoHS
Protection class IP20 / IP54	IP20 / IP54	IP20 / IP54



Our experts suggest the following AC-Magnets: WI 111, WI 121, WI 321, WI 421, WI 621, WI 211, WE 131

REOVIB MFS 268 **Patented System**

Frequency converters in the **REOVIB MFS 268** series for vibratory conveyor technology offer the option of operating the vibratory conveyor at an optimal vibration frequency for the material - with a wide input voltage range of 110 V to 230 V - completely independently of the frequency of the electrical mains supply. It is moreover possible, thanks to the system patented by REO, to determine the resonant frequency of the vibratory system automatically and to regulate the vibration amplitude to constant values.

Devices can optionally be equipped with field bus interfaces, and are also available as versions with UL/ CSA certification.

Devices in the REOVIB MFS 268 series are available with a max. output current of 3A, 6A, 8A, as IP20 versions for installation in switch cabinets, and also as IP54 case designs. The IP54 housing can be supplied with various connection options:

- Input cable/output cable
- Input cable/output socket
- Complete cable connection solution for mains, output and control connections

Advantages

- REO frequency units are able to control a vibratory conveyor independently of the mains input frequency
- Automatic search of the resonant frequency of the vibratory conveyor system (with additional vibration amplitude sensor) and option of regulating vibration amplitude –
- Able to regulate the vibration amplitude to maintain a constant feedrate irrespective of load or changes in the mechanical system
- Can be supplied with field bus interfaces: ProfiNet, EtherNet/IP, EtherCAT, CAN-Bus, Profibus, DeviceNet
- Optional versions available with UL/CSA accreditation
- Conveyor frequencies adjustable between 5...300 Hz
- Mains voltage compensation with constant vibration amplitude
- All settings can be made using the integrated display
- Sinusoidal output current
- Can be used on 110 V or 240 V autom. Detection
- User settings can be stored
- Fill level/overflow control
- Versions available in various protection classes and with various connection options
- MFS 269 is available with AC output signal for use with permanent-magnet armature.

REOVIB MFS 268 IP54
(with heat sink 6 A)



Suitable sensor:
REOVIB SW als IP54 Ausführung

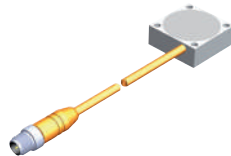

REOVIB MFS 268 IP20
ProfiNet*



*Also available with the following interfaces: EtherCat, Ethernet / IP, Profinet, Profibus, CAN-Bus, DeviceNet

Technical data

REOVIB MFS 268	
Mains input	110 / 230 V autom. Erkennung
Mains frequency	50 / 60 Hz +/- 3 Hz
Output voltage	0...100 V / 0...205 V
Output current	max. 3 A / 6 A / 8 A
Vibration frequency	5...150 Hz (Optional 300 Hz)
Setpoint value	Display, Poti, 0...10V, 0(4)...20 mA
Status signal	Relay changer 250 V, 1A (einstellbar)
Ready signal	Relay changer 250 V, 1A (einstellbar)
Ext. Enable	24 V DC, Schalter
Valve output	24 V, 150 mA (Option)
Sensor supply	24 V DC
Setting U_{min} / U_{max}	LED-Display
Soft start	einstellbar 0...60 Sek.
Soft stop	einstellbar 0...60 Sek.
Fill level/overflow control	PNP, 24 V DC
Coarse/fine control	✓
Vibration amplitude regulation	✓
Resonant frequency search	✓
Resonance frequency control	✓
Selectable timer function	✓
Sensor time out monitor *	✓
Mains voltage compensation	✓
Short-circuit detection	✓
Output current limitation	✓
Connection for thermal contact for Magnet temperature monitoring (Option)	-
Extra 24 V valve outlet as an option *1	✓
Field bus interfaces	ProfiNet, EtherNet/IP, EtherCat, Profibus-DP, CAN-Bus, DeviceNet,
Conformity	CE, RoHS , UL
Protection class	IP20 / IP54
Ambient temperature	0...45 °C



* For IP54

Typical applications: Conveyor & assembly automation, conveyor technology, sieving technology, filling and packaging technology

Interfaces



NEW - REOVIB 2.0

REOVIB MFS 368 **NEU** **Patentiertes System**

More technology in the same form – this is the motto of the new REOVIB MFS 368. The new devices consume up to 45% less electricity. This means that they do not only offer a better energy footprint, but also lower operating costs. This has been achieved by reactive power compensation. The lower power consumption is more eco-friendly thanks to the reduction in CO² emissions.

The frequency converters also have impressive effects on the conveying technology, with a wide input voltage range of 99 V to 264 V for a consistent output voltage of 250 V max. They also make it possible to operate the vibratory feeder at the optimal vibration frequency for the conveyed goods, completely independently of the frequency of the supply electrical network. The device can therefore be used worldwide. Where several different conveyors or magnets would have been required in the past, one REOVIB MFS 368 can now get the job done.

It is also possible to automatically determine the resonance frequency of the vibration system and control the vibration amplitude to set it at constant values by implementing the REO-patented ACC control procedure. The benefit of this is that the conveyor automatically works at the optimum conveying capacity independently of the load or mechanical settings. No time-consuming adaptation of the conveyor is required. The new REOVIB MFS 368 means that optimum and maximum conveying performances can be consistently achieved, such as when springs age or with changing mechanical loads or voltage fluctuations.

The new converter has an integrated active network filter, saving on additional costs for an external network filter and reducing power consumption. It also has an LCD display which shows full text. A temperature sensor for magnets can be connected if required to guarantee that there are no failures due to defective magnets and to increase the operational safety of the units.

The devices can be equipped with field bus interfaces if necessary and are also available in designs with UL/CSA certification. This permits simple use without unnecessary effort and tests in units in the USA and Canada.

The devices of the **REOVIB MFS 368** series are available with a max. output current of 3 A, 6A , 8 A as IP20 variant for switch cabinet installation as well as IP54 housing version. The IP54 enclosures can be supplied with various connection options:

- Input- and output cable
- Input cable and output plug
- Completely pluggable with input- and output plug and sensor connectors

Advantages

- Reduction of harmonics and thus of mains interferences
- Energy efficiency through reactive power compensation
- Active power is taken from the supply network
- Output voltage of 205 V with an input voltage range from 99 V to 264 V
- LCD display with full text menu
- Short-circuit detection
- Output current limitation
- Possibility (as an option) of connecting an external thermal contact for temperature monitoring of the magnets
- Extra 24 V valve outlet as an option
- The Device can be configured according to your requirements

REOVIB MFS 368 IP54

REOVIB 2.0
NEW
IIoT-Ready

REOVIB MFS 368 IP20 with interfaces

REOVIB 2.0
NEW
IIoT-Ready

Technical data

REOVIB MFS 368	
Input voltage	99 V ... 264 V
Mains frequency	50 / 60 Hz +/- 3 Hz
Output voltage	0...205 V
Output current	3 A / 6 A / 8 A
Vibration frequency	20...140 Hz * ¹
Setpoint setting	LCD-Display, 0 ... 10 V, 0 (4) ... 20 mA
Status signal	Relay changer 24 V, 1A
Ready signal	Relay changer 24 V, 1A
Ext. release	24 V DC, switch
Valve outlet	24 V, 100 mA
Sensor supply	24 V DC
Setting U_{min} / U_{max}	LCD-Display
Soft start	Adjustable 0...60 Sek.
Soft stop	Adjustable 0...60 Sek.
Level control/switching circuit	PNP, 24 V DC
Coarse/fine control	✓
Amplitude control	✓
Resonance frequency search	✓
Resonance frequency control	✓
Selectable cycle operation	✓
Sensor - Time Out control *	✓
Netzspannungskompensation	✓
Short-circuit detection	✓
Output current limitation	✓
Connection for thermal contact for Magnet temperature monitoring (Option)	✓
Extra 24V valve outlet as an option * ¹	✓
Fieldbus interfaces	ProfiNet, EtherNet/IP, EtherCat, Profibus-DP, CAN-Bus, DeviceNet,
Conformity	CE, RoHS (UL in the planning stage)
Protection classes	IP20, IP54
Ambient temperature	0...40 °C



* Für IP54
*¹ Other frequencies on request

Typical applications: Conveyor & assembly automation, sieving technology, filling and packaging technology

Interfaces



REOVIB MFS 268 HP Patentiertes System

High-power version of the REOVIB MFS 268 frequency-control device, can be used for mains voltages of 400 V with max. 8 or 16A output current and for mains voltages of 230 V with max. 12, 16, 32A output current. Available as IP20 versions for installation in control cabinets and also as IP54 standalone units for 230 V and 12/16A. We are also delighted to offer you a suitable control cabinet system with client specific requirements. Special designs of the REOVIB MFS 268 HP can also be implemented if required.

Advantages

- Independant of the mains input frequency
- Able to automatically determine the resonant frequency of the vibratory conveyor system (with additional vibration amplitude sensor) and regulate the vibration amplitude and maintain a constant feedrate irrespective of load or changes in the mechanical system
- Field bus interfaces: ProfiNet, EtherNet/IP, EtherCAT, CAN-Bus, ProfiBus, DeviceNet
- Available with UL/CSA approval depending on the type (Optional)
- Conveyor frequencies adjustable between 5...300 Hz
- Mains voltage compensation with constant vibration amplitude
- All settings can be made using the integrated display
- Sinusoidal output current
- Can be used on 230 V or 400 V mains input
- User settings can be stored
- Fill level/overflow control
- Versions available in various protection classes and connector options
- MFS 269 HP is available with AC output signal for use with permanent-magnet armature.

REOVIB MFS 268 HP IP20
(Version 230 V-12/16 A)



REOVIB MFS 268 HP IP 20
(Version 230 V - 32 A oder 400V - 16 A)



REOVIB MFS 268 HP
(special design)



REOVIB MFS 268 HP IP54
(Version 230V - 12/16A)



REOVIB MFS 268 HP
(As a complete control cabinet system)



REOVIB SW as IP54-Version,
Plug M12, 4-pin

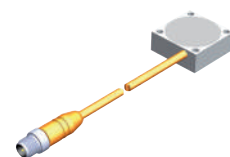

Technical data

REOVIB MFS 268 HP			
Mains input	115 / 230 V Auto Detect	115 / 230 V Auto Detect	230 / 400 V Auto Detect
Mains frequency	50 / 60 Hz +/- 3 Hz	50 / 60 Hz +/- 3 Hz	50 / 60 Hz +/- 3 Hz
Output voltage	0...100/0...205 V	0...100/0...205 V	0...205/0...360 V
Output current	max 12 / 16 A	max. 32 A	max. 8 / 16 A
Vibration frequency	5...150 Hz	5...150 Hz (Optional 300 Hz)	5...150 Hz (Optional 300 Hz)
Setpoint value	Display, Poti, 0 ... 10 V, 0 (4) ... 20 mA	Display, Poti, 0 ... 10 V, 0 (4) ... 20 mA	Display, Poti, 0 ... 10 V, 0 (4) ... 20 mA
Status signal	Relay changer 250 V, 1A	Relay changer 250 V, 1A	Relay changer 250 V, 1A
Ext. Enable	24 V DC, Switch	24 V DC, Switch	24 V DC, Switch
Valve output	24 V, 150 mA (IP 54)	-	-
Sensor supply	24 V DC	24 V DC	24 V DC
Setting Umin / Umax	Display	Display	Display
Soft start	Adjustable 0...60 Sek.	Adjustable 0...60 Sek.	Adjustable 0...60 Sek.
Fill level/overflow control	PNP, 24 V DC	PNP, 24 V DC	PNP, 24 V DC
Coarse/fine control	✓	✓	✓
Vibration amplitude regulation	✓	✓	✓
Resonant frequency search	✓	✓	✓
Selectable timer function	✓	✓	✓
Sensor time out monitor	✓	✓	✓
Mains voltage compensation	✓	✓	✓
Field bus interfaces	ProfiNet, EtherNet/IP, EtherCat, Profibus-DP, CAN-Bus, DeviceNet,		
Standard Conformity	CE, RoHS, UL/CSA (Option)	CE, RoHS	CE, RoHS
Protection class	IP20/IP54	IP20	IP20



Typical applications: Conveyor & assembly automation, conveyor technology, sieving technology, filling & packaging technology

Interfaces



REOVIB Measuring equipment

The [REOVIB Testbox 122](#) is designed to provide accurate indications of voltage and current, when servicing and testing vibratory conveyors. The devices are fitted with moving-iron meters and external connectors are provided to allow fast and safe connection of the feeder and controller.

The [REOVIB SWM 4000](#) handheld measurement unit is used to set up, test and service vibratory conveyor equipment. As a battery powered hand-held device, it is particularly suited for mobile work. Frequency [Hz], vibration amplitude [mm], vibrational velocity [cm/s] and vibrational acceleration [g] can be measured with an acceleration sensor. The values are indicated on the integrated LCD display and can also be stored in the equipment (40 measured values). The integrated USB interface can transfer this saved data to a PC, within a file, for further analysis.

The [REOVIB SWM 1000](#) sensor is designed to monitor vibratory feeders. The sensor measures the acceleration of a magnetically or motor driven vibrating feeder and supplies 0 (4)... 20 mA outputs for vibrational acceleration [g] and vibration amplitude [mm]. The output of the sensor can be connected directly to a measuring instrument (with 0 (4)... 20 mA input) or to a PLC controller for evaluation or monitoring.

The [REOVIB 6050](#) workshop device contains a REOVIB MFS frequency controller for vibratory conveyors and has been specially developed for use in servicing, construction and design of vibratory conveyors. For rapid control, the desired value of vibration amplitude is adjustable by means of a potentiometer and an integrated ammeter provides indication of the feeder running current.

[REOVIB 6100](#) workshop and diagnostic unit is a microprocessor-controlled device. An integrated REOVIB MFS frequency units controls the feeder, while simultaneously determining vibration frequency [Hz], vibration amplitude [mm], vibrational velocity [cm/s] and vibrational acceleration [g]. The values are shown on the integrated LCD display and can also be stored in the equipment (40 measured values). The integrated USB interface can transfer this saved data to a PC, within a file, for further analysis. The operating frequency of the conveyor can be set manually or can be determined independently using a vibration amplitude sensor with an automatic frequency search.

The [REOVIB SWM 843](#) monitoring device measures and displays the vibration performance of vibratory feeders. The vibration is monitored using an accelerometer and the instantaneous measured values are indicated on the five-digit seven-segment display, as a value of acceleration [g], vibration amplitude [mm] or vibration frequency [Hz]. The acceleration value is also provided as a 0 (4)... 20 mA analogue output for direct connection to a measurement instrument, or for connection to an external measurement device e.g. a PLC controller for evaluation or monitoring.

The [REOVIB BK 032](#) is a monitoring device which measures the vibration behaviour of vibratory feeders. This evaluation device when used in conjunction with an acceleration sensor, allows an acceptable window of operation to be established using adjustable maximum and minimum limits. If operation outside of this window occurs, which could signal a mechanical problem for example, a associated relay switches over which can be used to trigger an external alarm.

Our measuring equipment:

- [Testbox 122](#): Analog measurement instrument for testing vibratory conveyors
- [REOVIB 6050](#): Workshop equipment for assistance with development / design in the construction of vibratory conveyors
- [REOVIB 6100](#): Workshop and diagnostic unit for development, construction and quality control of vibratory conveyors.
- [REOVIB SWM 4000](#): Handheld instrument for testing vibratory conveyors.
- [REOVIB SWM 1000](#): Acceleration and vibration amplitude sensors for vibratory conveyors
- [REOVIB SWM 843](#): Monitoring device for vibrating feeders
- [REOVIB BK 032](#): Monitoring device for vibrating feeders

REOVIB SWM 4000



REOVIB 6050



REOVIB Testbox 122



REOVIB SWM 843



REOVIB SWM 1000



REOVIB 6100



Technical data

REOVIB Measuring equipment				
	Testbox 122	REOVIB 6050	REOVIB 6100	SWM 4000
Description	Analog instrument with moving-iron meters	Workshop equipment used for servicing and manufacturing of vibratory conveyors	Workshop and diagnostic equipment used for the development, construction and quality control of vibratory conveyors	Hand-held instrument for checking and testing vibratory conveyors
Function	Measurement of current and voltage of the drive system	Driving the conveyor with a frequency controller, determining the resonant frequency, measurement of the solenoid current.	Driving the conveyor with a frequency controller, determining the resonant frequency, measurement of the magnet current. Measuring acceleration, vibration amplitude, vibration frequency and theoretical conveyor speed	Independent measurement of vibration frequency, vibration amplitude, vibrational acceleration, and vibrational velocity. No drive

REOVIB Measuring equipment			
	SWM 1000	SWM 843	REOVIB BK 032
Description	Acceleration and vibration amplitude sensor for vibrating feeders	Monitoring device for vibrating feeders	Monitoring device for vibrating feeders
Function	Independent measurement of vibration amplitude and vibrational acceleration. An analogue measured value of each is output for display on a measuring instrument or for monitoring by a PLC	Measurement of frequency, amplitude or acceleration. Display of the measured value on an integrated LED display. Output of an analogue measurement signal. Relay outputs to show that adjustable min. and max. values of acceleration have been reached	Measurement of the acceleration of vibrating feeders. Relay outputs to show that adjustable min. and max. values of acceleration have been reached.



REOVIB Accelerometers

Advantages

- Aluminum housing
- Low-cost versions available
- Designed for harsh environmental conditions (optional)
- Light weight
- Plug + Play functionality with the
- REOVIB MFS 168+268 controllers and measuring devices
REOVIB REOVIB 6050 and 6100

REOVIB SW als IP65-Version,
cable with open ends

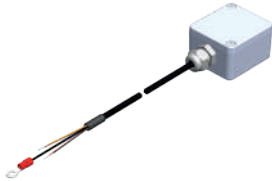

REOVIB SW als IP54-Version,
plug M12, 4-pin

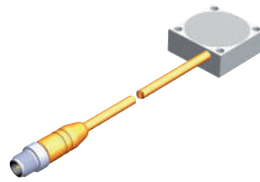

Technical data

REOVIB Accelerometers							
Type	SW 07	SW 80	SW 40	SW 41	SW 42	SW 09	SW 85
Protection class	IP65 (Diecast aluminium)						IP65 (Diecast aluminium)
Connection type	Cable with open ends						plug M12, 4-pin
Measurement signal [mV/g]	300	300	600	600	600	2000	300
Frequency range [Hz]	30...150	30...150	10...60	10...60	10...60	5...20	30...150
Cable length [m]	5	16	5	10	15	2	5

REOVIB Accelerometers								
Type	SW 61	SW 12	SW 10	SW 22	SW 50	SW 53	SW 15	SW 51
Protection class	IP65 (Diecast aluminium)							
Connection type	Cable with open ends							
Measurement signal [mV/g]	100	300	300	300	300	300	300	300
Frequency range [Hz]	60...250	30...150	30...150	30...150	30...150	30...150	30...150	30...150
Cable length [m]	5	1	2	2,5	5	5	10	10

REOVIB Accelerometers								
Type	SW 52	SW 54	SW 30	SW 29	SW 28	SW 27	SW 26	SW 14
Protection class	IP65 (Diecast aluminium)							
Connection type	Cable with open ends							
Measurement signal [mV/g]	300	300	600	600	600	600	600	2000
Frequency range [Hz]	30...150	30...150	10...60	10...60	10...60	10...60	10...60	5...20
Cable length [m]	15	30	2	3	5	10	15	10

REOVIB Accelerometers											
Type	SW 62	SW 66	SW 70	SW 69	SW 71	SW 68	SW 67	SW 72	SW 73	SW 74	SW 75
Protection class	IP65 (Diecast aluminium)										
Connection type	plug M12, 4-pin										
Measurement signal [mV/g]	100	150	300	300	300	300	300	600	600	600	600
Frequency range [Hz]	60...250	60...200	30...150	30...150	30...150	30...150	30...150	10...60	10...60	10...60	10...60
Cable length [m]	5	2	2	3	5	10	15	2	5	10	15



REOVIB Connection accessories

Advantages

- Straightforward plug and socket solutions for REOVIB control and measuring equipment
- Various versions (straight/90° angle)
- Various types of material (metal, plastic)

Output plug, black, 90° angle



Input connector grey, 90° angle



Input coupling metal, straight



Sensor plug 5 pin M12



Sensor plug 4 pin M12



Technical data

REOVIB Connection accessories			
	Output plug	Input connector	Sensor plugs
Material	Plastic, grey	Plastic, grey	Plastic, grey
	Plastic, black	Plastic, black	Plastic, black
	Metal	Metal	Metal
Variante	Straight	Straight	4 pin M12
	90° angle	90° angle	5 pin M12



REOVIB 2.0

The world's safest and most modern control!

- REOVIB MFS 368, SMART-MIC, MTS 620
- REOVIB AC-Magnets
- IIoT-Ready

All information about the new series can be found on:

www.reovib.com



REONET

NEW

The simple way
Always be connected

Industry 4.0 is making production digital. Digital technologies and processes enable completely new approaches in production and services. As the industry progressively evolves, the demands on production and communication increase in regards to scalability and interoperability.

With REO, you have a competent partner at your side to successfully deal with the challenges of Industry 4.0. To this end, REO will equip its devices IIOT-Ready and introduce specially developed hardware and software solutions.

Using the REONET DL interface, you can access devices over a traditional network infrastructure. By using OPC UA, REONET DL enables participation in the world's largest standards-based ecosystem.

We additionally offer the possibility to simplify the configuration of devices with the REONET CT software. A web interface can be used to create and distribute configurations for devices. The automated process ensures that no parameters are left out and the devices are delivered as intended. In addition, the software offers the possibility to save configurations so that they can be adapted or restored at any time.

REOVIB AC-Magnets

Useful facts	P. 35
REOVIB WI 111	P. 36-37
REOVIB WI 121	P. 38-39
REOVIB WI 421	P. 40-41
REOVIB WI 721	P. 42-43
REOVIB WI 211	P. 44-45
REOVIB WE 131	P. 46-47
Service	P. 48
General informations	P. 49

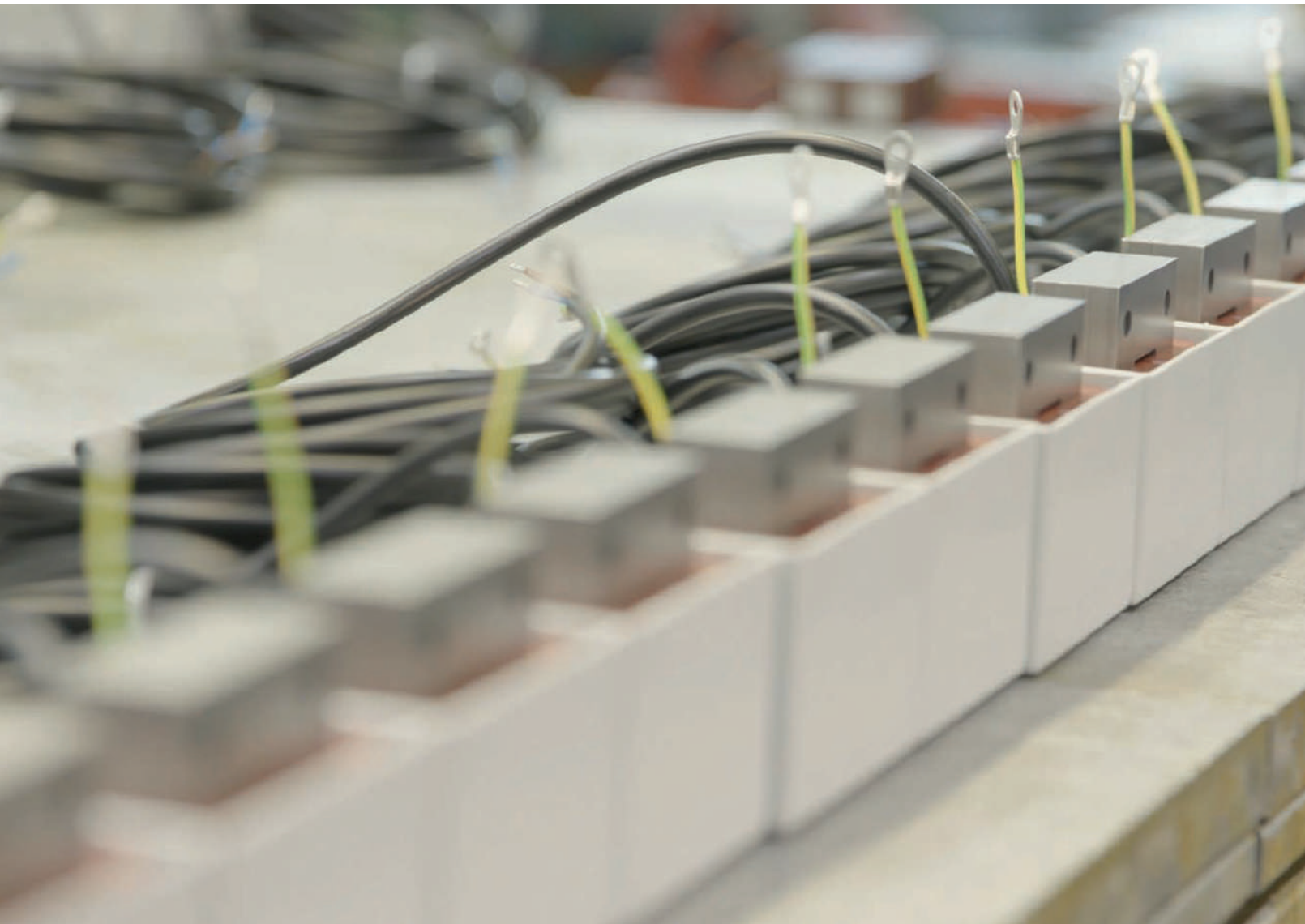

Useful facts about REOVIB

AC-Magnets

General informations

The complete electromagnet consists of the core bearing the winding and the corresponding armature (l Piece). The electromagnet, the armature and the leaf springs form the drive system of the vibratory feeder. The weight differential between the resting mass, the oscillating mass and the spring force result in a resonant vibration system. Vibratory feeders can therefore only work in a relatively small frequency range around the resonance point. All components of the entire drive system must be adjusted to this frequency. It is therefore important that the electromagnet is constructed for the correct frequency otherwise the total power of the magnet cannot be utilised or it could become overheated due to increased losses. Due to conventional control systems, most vibratory feeders work with the same or double vibration frequency of the connection power. 50 Hz or 100

Low frequency vibration systems

Low frequency systems with vibration frequencies of approximately 15 Hz and 25 Hz are used for particular applications (bulk conveying or product with special feeding characteristics); these systems must be operated with special frequency converters (REOVIB MFS).

Vibration frequency

In addition to the frequency specification in Hz, also the terms "full wave" (6000 vibrations/ minute) or "half-wave" (3000 vibrations/minute) have become customary for specification of the vibration frequency.

The terms "full wave" and "half-wave" are derived from the sinusoidal wave of the power frequency:

With half-wave = 50 Hz (60 Hz) a sinusoidal half-wave is blocked by a diode or a triac.

With a full wave = 50 Hz (60 Hz) the positive and negative half-waves each produce vibration.

33000 vibrations/min = 50 Hz (50 x 60 sec), or
6000 vibrations/min = 50 Hz (100 x 60 sec) are comparable with the specification of revolutions per minute (rpm) for a motor.

It is important that the mechanical vibration frequency of the feeder system, the air gap as well as the type of drive control (output voltage and output frequency) are considered in the electrical design of the electromagnets.

AC-Magnets, series*

Series REOVIB WI 111

Standard series, fully encapsulated, maximum power of 350 VA at 3000 1/min or 6000 1/min

- Mounting by means of standard round holes, base plate or slotted holes
- Cable exit downwards or sideways

Series REOVIB WI 121

Standard series, fully encapsulated, maximum power 3900 VA at 3000 1/min or 6000 1/min

- Mounting with blind tapped holes at the base of the magnet and armature
- Cable exit downwards with unshielded or shielded cable

Series REOVIB WI 421

Nickel-plated model, fully encapsulated at 900 1/min, 1500 1/min, 3000 1/min or 6000 1/min, maximum power 1265 VA

- Mounting with blind tapped holes at the base of the magnet and armature
- Cable exit downwards with unshielded or shielded cable

Series REOVIB WI 721

NEW FDA approved

Powder-coated model, fully encapsulated at 900 1/min, 1500 1/min, 3000 1/min or 6000 1/min, maximum power 3900 VA

- Mounting with blind tapped holes at the base of the magnet and armature
- Cable exit downwards with unshielded or shielded cable

Series REOVIB WI 211

Series with configurable voltage/frequency options, fully encapsulated, maximum power 250 VA at 3000 1/min or 6000 1/min

- Mounting by means of standard round holes, base plate or slotted holes
- Cable exit downwards or sideways

Series REOVIB WE 131

Series in EI shape, maximum power 690 VA at 3000 1/min or 6000 1/min

- Mounting with blind tapped holes at the base of the magnet and armature

*In addition to the listed series we also offer special solutions / customer-specific magnets.

REOVIB WI 111

Advantages

- Optimal size/performance ratio
- Good adjustability
- Safe mounting by means of solid base plate/ mountings through core
- Compact and robust structure

Mounting by means of base plate (optional)

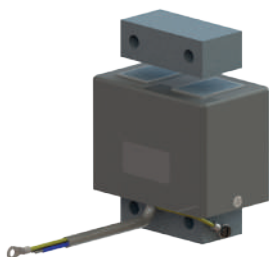

Technical data

Vibration frequency 3000 / 6000 1/min

REOVIB WI 111						
Types	Maximum rated air gap [mm]	Power at 3000 1/min [VA]	Rated current = thermal rated current at 230 V [A]	Peak tensile force at nominal air gap [N]	Weight [kg]	
		6000 1/min [VA]			Magnet	Armature
REOVIB WI 111/3	2	15	0,065	5	0,135	0,025
REOVIB WI 111/5	1	60	0,26	38	0,405	0,085
REOVIB WI 111/6	2,5	70	0,3	24	0,58	0,11
REOVIB WI 111/7	3	140	0,6	45	1,15	0,165
REOVIB WI 111/9	3	350	1,5	150	1,98	0,33



Compatible REOVIB devices: REOVIB SMART, REOVIB RTS, REOVIB MTS, REOVIB MFS
 Typical applications: REOVIB SMART, REOVIB RTS, REOVIB MTS, REOVIB MFS

Dimensions in mm

REOVIB WI 111																					
Types	a	b	c	d	e	f1	f2	f3	g	h	l	k	l1	m	ø n	ø o	p	ø r	s	ø t	
REOVIB WI 111/3	44,4	26,4	30	32	2	42	9	5	30	12	10	4,2	22	20	22	4,2	4,4	-	4,4	20	3,6
REOVIB WI 111/5	61,5	31,5	45	50	3	63	14	7,5	45	16	15	3	43	35	36	4,2	4,4	15	5,1	28	5,1
REOVIB WI 111/6	64	42	45	50	3	63	14	7,5	45	20,5	15	-	43	35	36	4,2	4,4	15	5,1	28	5,1
REOVIB WI 111/7	78	47	54	60	3	77	17	10	54	21	20	4,5	45	40	45	7	5,5	20	6,5	37	6,5
REOVIB WI 111/9	90	56	66	83	3	88	19	11	66	32,5	22	-	66	50	66	7	6,4	44	8,1	44	8,1

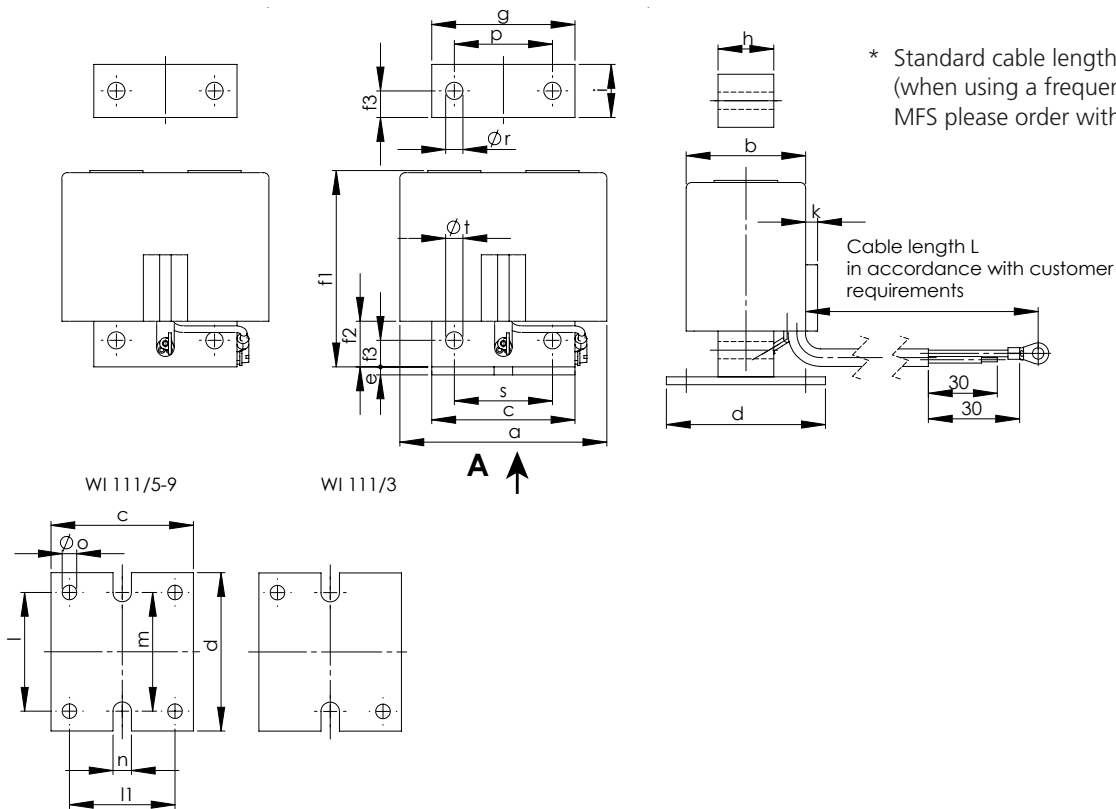

* Standard cable length: 0,2m and 1m
(when using a frequency control REOVIB MFS please order with shield)

REOVIB WI 121

Standard series

Advantages

- Optimal size/performance ratio
- Good adjustability
- Maximum power 3900 VA
- Maximum tractive power 6900 N
- Low Profile

REOVIB WI 121

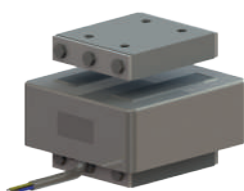

Technical data

Vibration frequency 3000 / 6000 1/min

REOVIB WI 121									
Types	Maximum rated air gap [mm]	Power at 6000 1/min [VA]	Rated current = thermal rated current at 230V [A]	Peak tensile force at nominal air gap [N]	Power at 3000 1/min [VA]	Therm. rated current at 230V [A]	Peak tensile force at nominal air gap [N]	Weight [kg]	
								Magnet	Armature
REOVIB WI 121/10	2,5	320	1,4	230	280	1,2	229	2,1	0,34
REOVIB WI 121/12	3	450	1,95	330	425	1,85	318	2,8	0,62
REOVIB WI 121/14	3	1200	5,2	850	1100	4,8	1350	6,9	1,45
REOVIB WI 121/16	3	2200	9,5	1590	1890	8,2	2620	10,5	2,6
REOVIB WI 121/18	3	-	-	-	3900	16,9	6900	28	9



Compatible REOVIB devices: REOVIB SMART, REOVIB RTS, REOVIB MTS, REOVIB MFS

Typical applications: Packaging industry, weighing sector for feeding, sorting processes, automation process, assembly equipment which utilises electromagnetic drives

Dimensions in mm

REOVIB WI 121												
Types	a	b	c	d	f1	f2	f3	g	h	i	p	r
REOVIB WI 121/10	100	68	66	-	61,5	12	9	66	38	17,5	30	M6
REOVIB WI 121/12	100	100	66	40	61,5	15	9	66	70	17,5	30	M6
REOVIB WI 121/14	155	110	108	-	90,5	23	15	108	68	26,5	50	M10
REOVIB WI 121/16	155	168	108	80	90,5	23	15	108	126	26,5	50	M10
REOVIB WI 121/18	230	170	169	65	128,5	42	18	169	120	47,5	75	M12

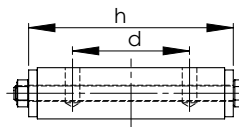
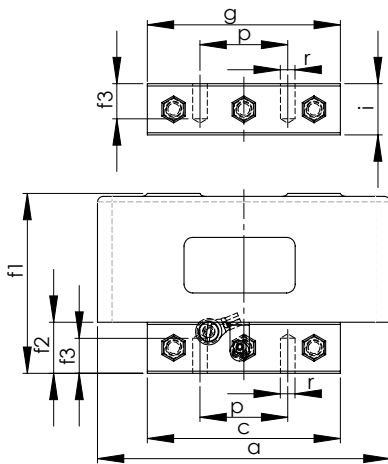

* Standard cable length: 1m
(when using a frequency control REOVIB MFS please order with shield)

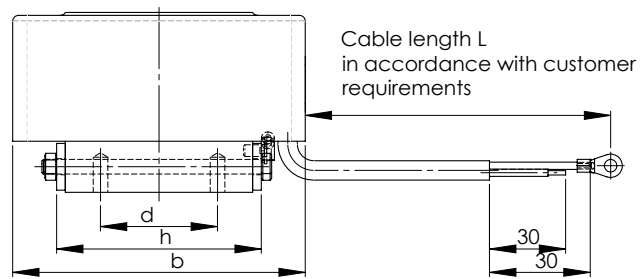

REOVIB WI 421

Nickel-plated model

Advantages

- Corrosion protection by means of nickel plating
- Optimal size/performance ratio
- Good adjustability
- Maximum power 2020 VA
- Also for low frequency applications
- Maximum tractive power 2900 N
- Low Profile



Technical data

Vibration frequency 3000 / 6000 1/min

REOVIB WI 421									
Types	Maximum rated air gap [mm]	Power at 6000 1/min [VA]	Rated current = thermal rated current at 230V [A]	Peak tensile force at nominal air gap [N]	Power at 3000 1/min [VA]	Therm. rated current at 230V [A]	Peak tensile force at nominal air gap [N]	Weight [kg]	
								Magnet	Armature
REOVIB WI 421/10	2,5	200	0,87	110	156	0,68	128	2,1	0,34
REOVIB WI 421/12	3	350	1,52	150	300	1,3	264	2,8	0,62
REOVIB WI 421/14	3	800	3,5	580	748	3,25	570	6,9	1,45
REOVIB WI 421/16	3	1600	6,9	1500	1265	5,5	1400	10,5	2,6
REOVIB WI 421/18	3	-	-	-	2020	8,8	2900	28	9



Compatible REOVIB devices: REOVIB SMART, REOVIB RTS, REOVIB MTS, REOVIB MFS

Typical applications: Packaging industry, weighing sector for feeding and sorting processes, automation process and assembly equipment which utilises electromagnetic drives, particularly suited for the food processing sector and the pharmaceutical sector

Dimensions in mm

REOVIB WI 421												
Types	a	b	c	d	f1	f2	f3	g	h	i	p	r
REOVIB WI 421/10	100	68	66	-	61,5	12	9	66	38	17,5	30	M6
REOVIB WI 421/12	100	100	66	40	61,5	15	9	66	70	17,5	30	M6
REOVIB WI 421/14	155	110	108	-	90,5	23	15	108	68	26,5	50	M10
REOVIB WI 421/16	155	168	108	80	90,5	23	15	108	126	26,5	50	M10
REOVIB WI 421/18	230	170	169	65	128,5	42	18	169	120	47,5	75	M12

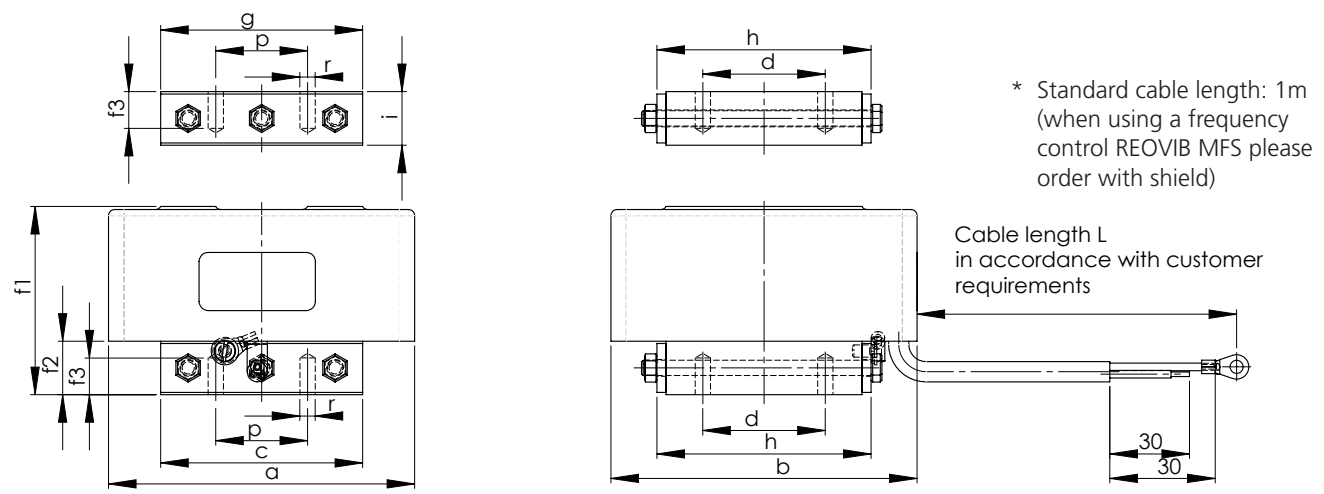

REOVIB WI 721

Powder-coated model

Advantages

- Corrosion protection by means of powder-coating
- FDA compliant
- Optimal size/performance ratio
- Good adjustability
- Maximum power 3900 VA
- Also for low frequency applications
- Maximum tractive power 6900 N
- Low Profile

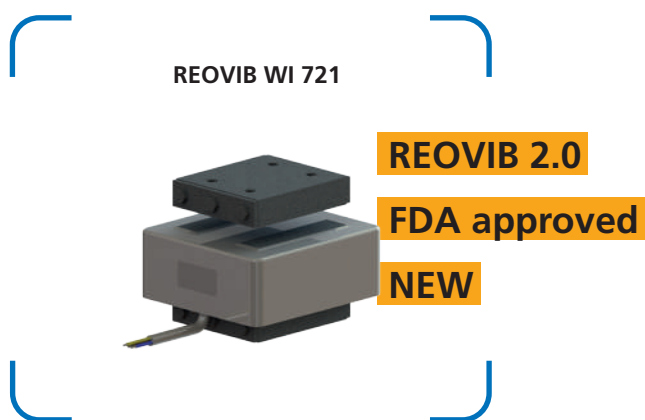

Technical data

Vibration frequency 3000 / 6000 1/min

REOVIB WI 721									
Types	Maximum rated air gap [mm]	Power at 6000 1/min [VA]	Rated current = thermal rated current at 230V [A]	Peak tensile force at nominal air gap [N]	Power at 3000 1/min [VA]	Therm. rated current at 230V [A]	Peak tensile force at nominal air gap [N]	Weight [kg]	
								Magnet	Armature
REOVIB WI 721/10	2,5	320	1,4	230	280	1,2	229	2,1	0,34
REOVIB WI 721/12	3	450	1,95	330	425	1,85	318	2,8	0,62
REOVIB WI 721/14	3	1200	5,2	850	1200	5,2	1410	6,9	1,45
REOVIB WI 721/16	3	2200	9,5	1590	1890	8,2	2620	10,5	2,6
REOVIB WI 721/18	3	-	-	-	3900	16,9	6900	28	9



Compatible REOVIB devices: REOVIB SMART, REOVIB RTS, REOVIB MTS, REOVIB MFS

Typical applications: Packaging industry, weighing sector for feeding and sorting processes, automation process and assembly equipment which utilises electromagnetic drives, particularly suited for the food processing sector and the pharmaceutical sector (FDA-conform)

Dimensions in mm

REOVIB WI 721												
Types	a	b	c	d	f1	f2	f3	g	h	i	p	r
REOVIB WI 721/10	100	68	67	-	62,5	12,5	9	67	39	18,5	30	M6
REOVIB WI 721/12	100	100	67	40	62,5	15,5	9	67	71	18,5	30	M6
REOVIB WI 721/14	155	110	109	-	91,5	23,5	15	109	69	27,5	50	M10
REOVIB WI 721/16	155	168	109	80	91,5	23,5	15	109	127	27,5	50	M10
REOVIB WI 721/18	230	170	170	65	129,5	42,5	18	170	121	48,5	75	M12

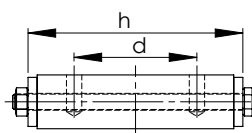
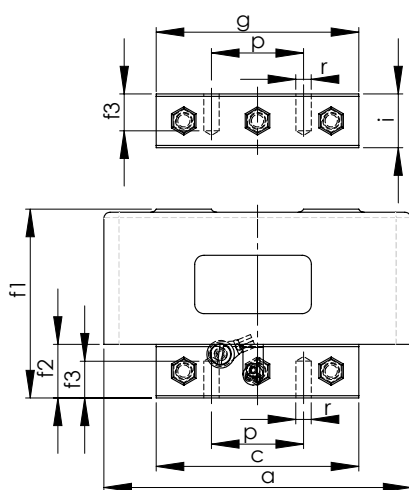

* Standard cable length: 1m
(when using a frequency control
REOVIB MFS please order with
shield)

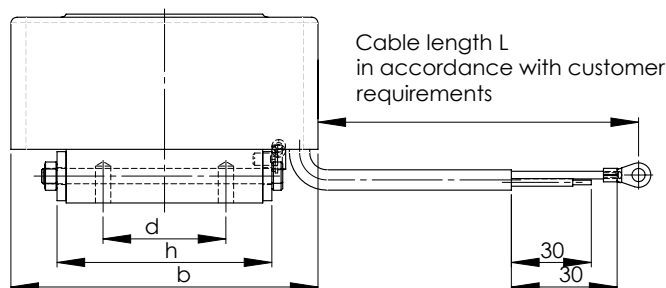

REOVIB WI 211

With configurable voltage/frequency options

Advantages

- Maximum power 250 VA
- Configurable voltage/frequency options increases flexibility
- Quick change of the connection voltage by using the appropriate selector key

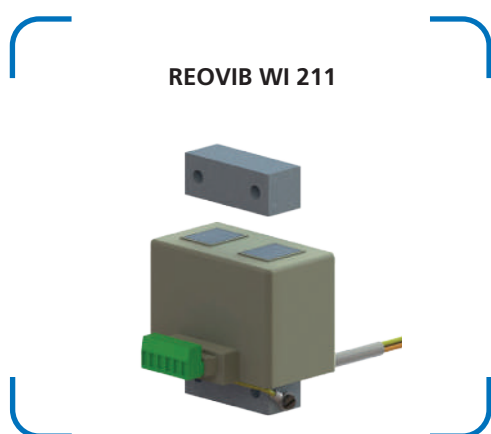

Technical data

Vibration frequency 3000 / 6000 1/min

REOVIB WI 211						
Types	Maximum rated air gap [mm]	Power at 3000 1/min [VA]	Rated current = thermal rated current at 230V [A]	Peak tensile force at nominal air gap [N]	Weight [kg]	
		6000 1/min [VA]			Magnet	Armature
REOVIB WI 211/7	1	175	0,75	40	1,15	0,165
REOVIB WI 211/9	1	210	0,9	105	1,96	0,33
REOVIB WI 211/10	1	250	1,1	210	2,1	0,34



Compatible REOVIB devices: REOVIB SMART, REOVIB RTS, REOVIB MTS, REOVIB MFS

Typical applications: Packaging industry, weighing sector for feeding and sorting processes, automation process and assembly equipment which utilises electromagnetic drives

Dimensions in mm

REOVIB WI 211																		
Types	a	b	c	d	e	f	f1	f2	f3	f4	g	h	i	k	p	r	s	øt
REOVIB WI 211/7	78	47	54	60	3	77	74	17	10	22	54	21	20	31	20	6,5	37	6,5
REOVIB WI 211/9	90	56	66	83	3	91	88	19	11	24	66	32,5	22	31	44	8,1	44	8
REOVIB WI 211/10	100	68	66	-	-	-	61,5	12	9	48	66	38	17,5	31	30	M6	-	-

Standard: without base plate

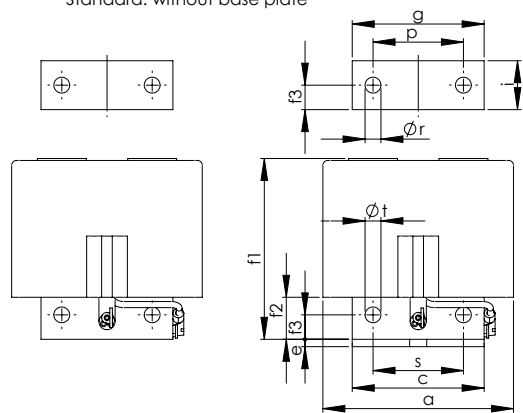

with base plate

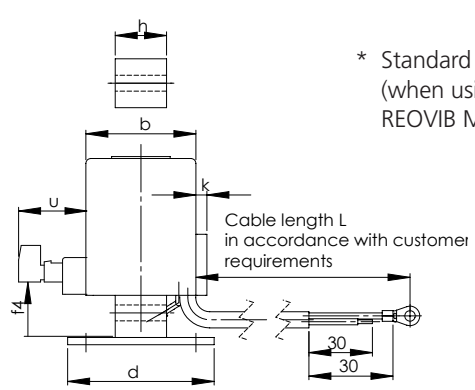

* Standard cable length: 0,2m and 1m
(when using a frequency control REOVIB MFS please order with shield)

with voltage/frequency selector

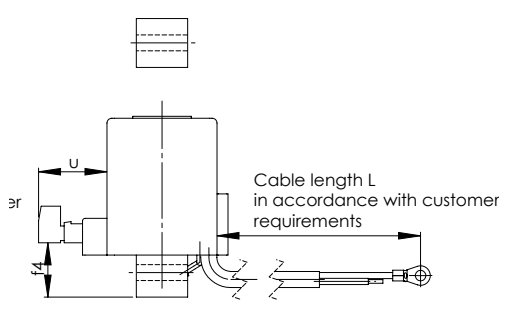

View A
Base plate for all types

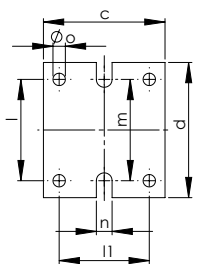

REOVIB WE 131

AC electromagnets with EI core

Advantages

- Maximum power 690 VA
- Low Profile
- Particularly suited for small air gaps

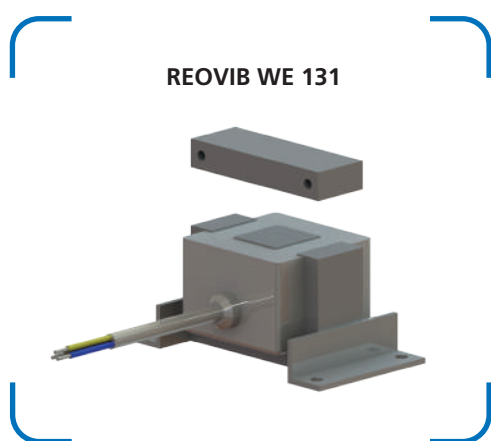

Technical data

Vibration frequency 3000 / 6000 1/min

REOVIB WE 131					
Types	Maximum rated air gap [mm]	Power at 3000 1/min [VA]	Rated current = thermal rated current at 230V [A]	Weight [kg]	
		6000 1/min [VA]		Magnet	Armature
REOVIB WE 131/75	0,5	110	0,5	1,4	0,27
REOVIB WE 131/135	0,8	460	2	7,2	1,6
REOVIB WE 131/136	0,6	690	3	8,7	2,2



Compatible REOVIB devices: REOVIB SMART, REOVIB RTS, REOVIB MTS, REOVIB MFS

Typical applications: Packaging industry, weighing sector for feeding and sorting processes, automation process and assembly equipment which utilises electromagnetic drives

Dimensions in mm

REOVIB WE 131															
Types	a	b	c	d	f1	f2	f3	g	h	i	l	l1	p	ør	øt
REOVIB WE 131/75	75	88	115	80	50	11	3	75	40	12,5	56	98	62,5	4,5	7
REOVIB WE 131/135	135	125	175	110	90	18	3	135	70	22,5	155	90	112,5	7,5	7
REOVIB WE 131/136	135	150	175	110	90	18	3	135	95,5	22,5	155	90	112,5	7,5	7

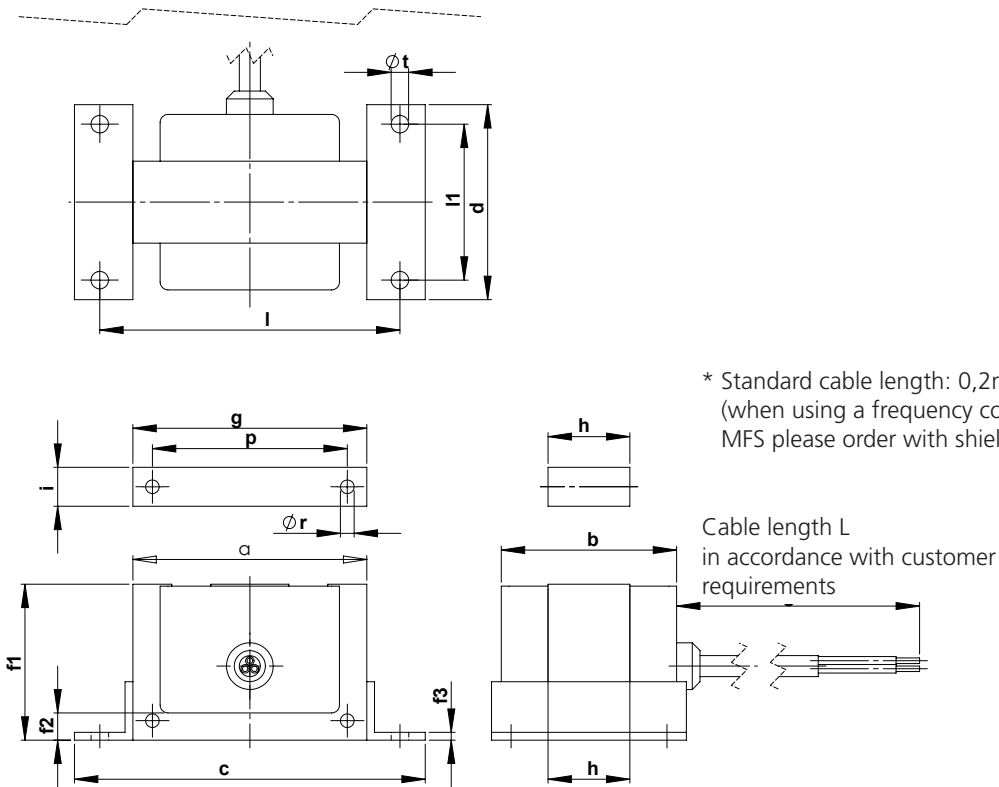

Our service for you

In addition to the standard electromagnets, REO has developed a range of special solutions - for example water-cooled electromagnets which are used in very hot ambient temperatures. Are you also looking for a special requirement? Our team members are happy to assist - please contact us!

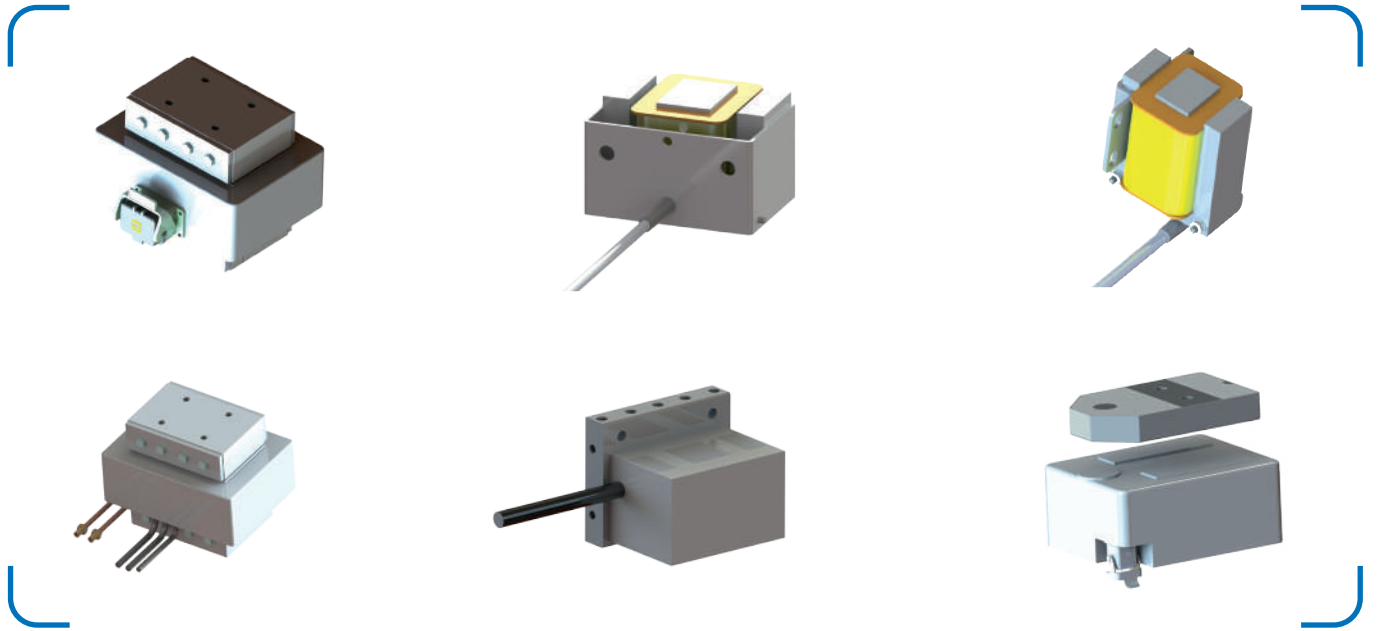

Principle of operation

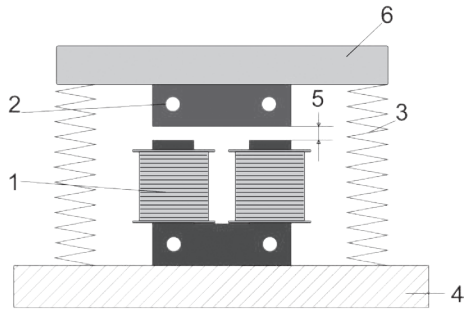

- 1 Core with excitation winding
- 2 Armature
- 3 Spring system
- 4 Fixed counterweight
- 5 Air gap
- 6 Vibrating tray

Structure of AC-magnets

REO AC magnets are generally built with a UI core. The U core has a winding on each leg and is fully encapsulated; the corresponding I core does not have any windings. Depending on the design, the connection cables are available as standard sheathed cables or shielded cables. They can be fed below on or the side. The AC magnets are affixed through holes in the core lamination or through the welded-on base plate. REO AC magnets are available in protection classes from IP00 to IP54.

With more than 20 years of experience REO is one of the leading suppliers in the vibratory feeding sector. REO electromagnets are reliable and field proven, and are suitable for industrial operation and laboratory operation as well as for food applications or pharmaceutical applications.

Designs with maximum power of 350 VA

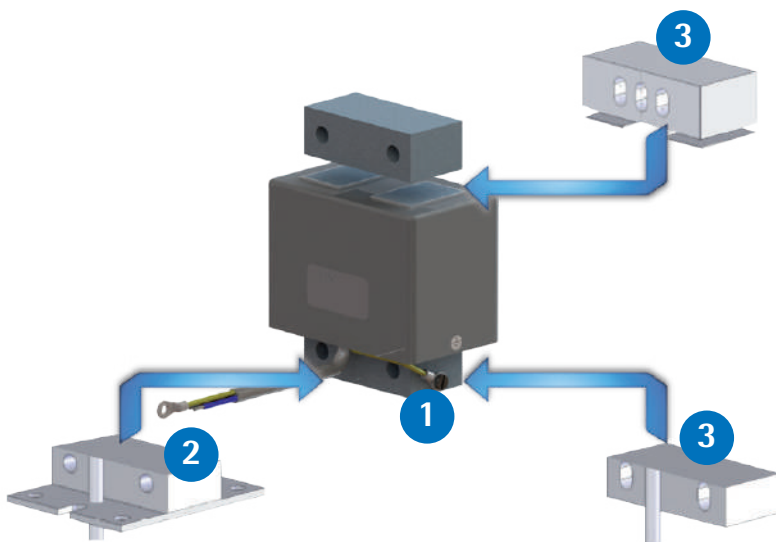

Cable models up to 350 VA

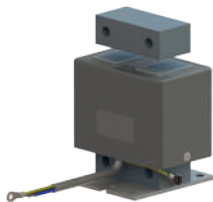

* Standard cable length: 0,2m and 1m
(when using a frequency control REOVIB MFS please order with shield)

Designs with maximum power of 4000 VA

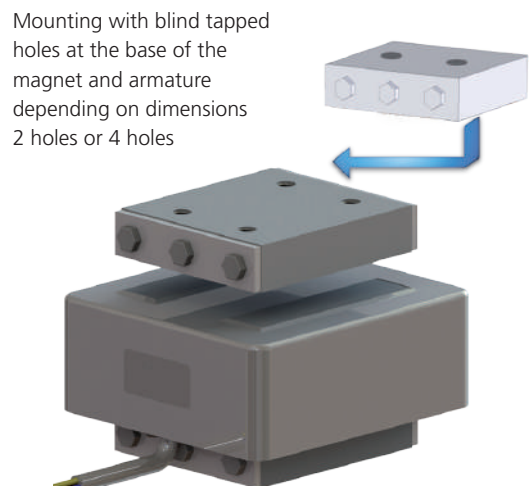

Cable models up to 4000 VA

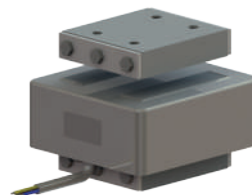

* Standard cable length: 1m
(when using a frequency control REOVIB MFS please order with shield)

EVERYTHING FROM A SINGLE SOURCE!

The right solution for any area of application!

REOunity - inductive components
for perfect power quality in your switchgear!

Have you already seen
our drive solution?

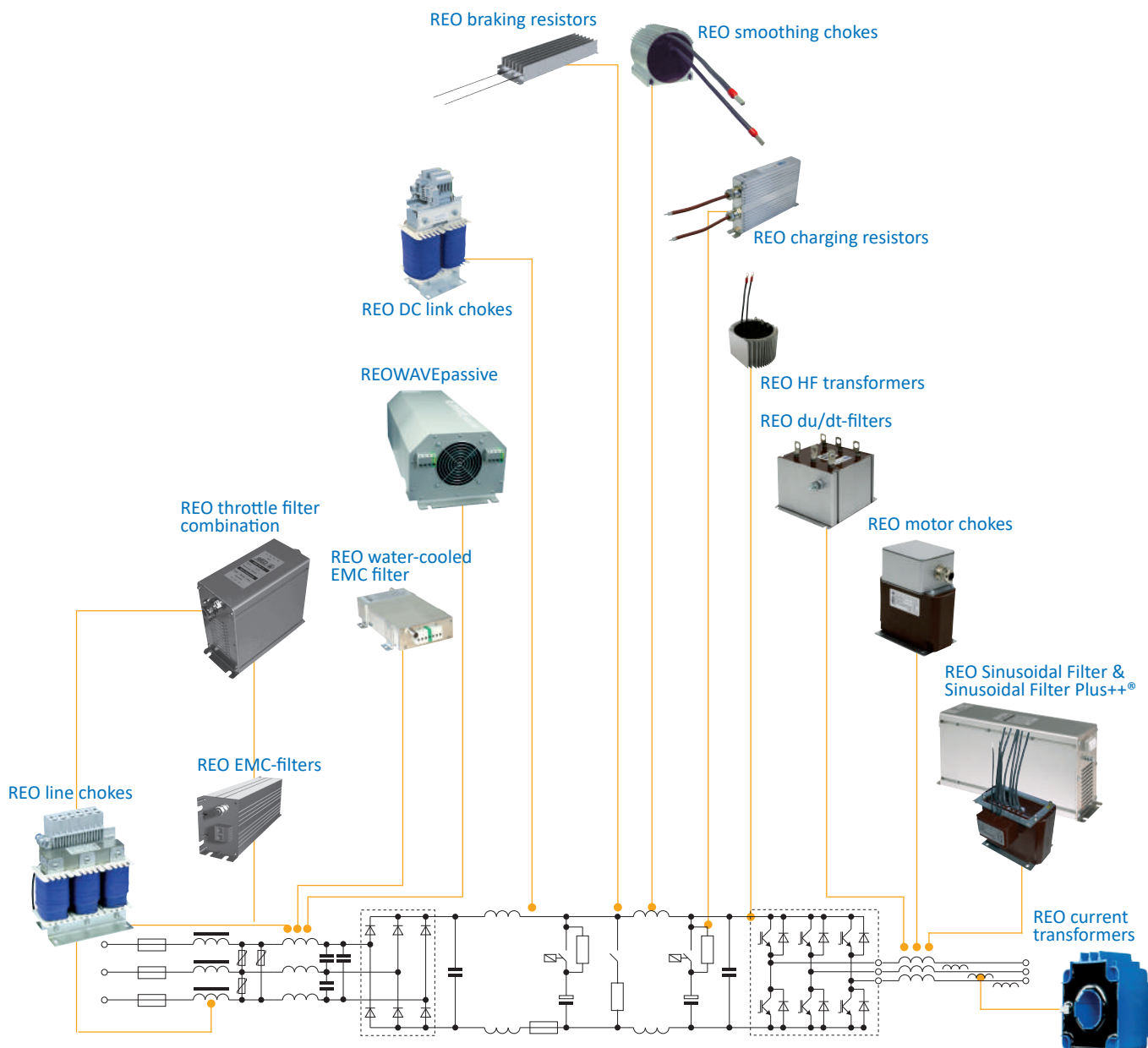

DRIVEN BY TECHNOLOGY

- Tomorrow's innovations
- Sector solutions with market impact
- Insights into the world of REO AG

All information can be found on:

www.image.reo.de



REO AG
Brühler Straße 100 · D-42657 Solingen
Tel.: +49 (0)212 8804 0 · Fax: +49 (0)212 8804 188

E-Mail: info@reo.de
Internet: www.reo.de



DIVISIONS:

REO Vibratory Feeding and Power Electronics Division

Brühler Straße 100 · D-42657 Solingen
Tel.: +49 (0)212 8804 0 · Fax: +49 (0)212 8804 188
E-Mail: info@reo.de

REO Train Technologies Division

Erasmusstraße 14 · D-10553 Berlin
Tel.: +49 (0)30 3670236 0 · Fax: +49 (0)30 3670236 10
E-Mail: zentrale.berlin@reo.de

REO Drives Division

Holzhausener Straße 52 · D-16866 Kyritz
Tel.: +49 (0)33971 485 0 · Fax: +49 (0)33971 485 90
E-Mail: zentrale.kyritz@reo.de

REO Medical and Current Transformer Division

Schuldholzinger Weg 7 · D-84347 Pfarrkirchen
Tel.: +49 (0)8561 9886 0 · Fax: +49 (0)8561 9886 40
E-Mail: zentrale.pfarrkirchen@reo.de

REO Test and PowerQuality Division

Brühler Straße 100 · D-42657 Solingen
Tel.: +49 (0)212 8804 0 · Fax: +49 (0)212 8804 188
E-Mail: info@reo.de

PRODUCTION + SALES:

India

REO GPD INDUCTIVE COMPONENTS PVT. LTD
E-Mail: info@reogpd.com · Internet: www.reo-ag.in

USA

REO-USA, Inc.
E-Mail: info@reo-usa.com · Internet: www.reo-usa.com

SALES:

China

REO Shanghai Inductive Components Co., Ltd
E-Mail: info@reo.cn · Internet: www.reo.cn

France

REO VARIAC S.A.R.L.
E-Mail: reovariac@reo.fr · Internet: www.reo.fr

Great Britain

REO (UK) Ltd.
E-Mail: main@reo.co.uk · Internet: www.reo.co.uk

Italy

REO ITALIA S.r.l.
E-Mail: info@reoitalia.it · Internet: www.reoitalia.it

Poland

REO CROMA Sp.zo.o
E-Mail: croma@croma.com.pl · Internet: www.croma.com.pl

Spain

REO ESPAÑA 2002 S.A.
E-Mail: info@reospain.com · Internet: www.reospain.com

Switzerland

REO ELEKTRONIK AG
E-Mail: info@reo.ch · Internet: www.reo.ch

Turkey

REOTURKEY ELEKTRONIK San. ve Tic. Ltd. Şti.
E-Mail: info@reo-turkey.com · Internet: www.reo-turkey.com