



**REO-USA, Inc.**  
 3250 North Post Road, Suite 132  
 Indianapolis, IN 46226  
 Phone (317) 899-1395  
 Fax (317) 899-1396

e-mail: [info@reo-usa.com](mailto:info@reo-usa.com)  
 web: [www.reo-reo.com](http://www.reo-reo.com)

**REOVIB MFS 268**  
 Frequency controllers for vibratory feeders

Operating instructions



MFS 268XL 12A  
 ID# 626867



MFS 268 IP20 16A  
 ID# 621103



MFS 268XXL 16A  
 ID# 626887

**Features**

- Feeder operating frequency is adjustable and independent of mains frequency.
- Constant feed rate ensured by internal compensation, irrespective of mains fluctuations.
- Integrated track control via backlog sensor.
- 24 V DC output for operating an air valve (IP 54 version), and amplitude control (sensor required).
- Independent resonant frequency search possible for feeder.
- Enable input (start / stop), status relay (output active / inactive).
- Stand-alone housings (IP 54) or panel-mounted units (IP 20).

**Technical data:**

Supply voltage	110 / 240 V, +/- 10%, 50/60 Hz
Output	0...100 / 0... 205 V, 3 A, 6 A, 8 A, 12A, 16A
Output frequency	5...300 Hz, (preset at 35... 140 Hz)
Enable input	Contacts or 24 V, DC
Track sensor	24 V, PNP (100 mA)
Solenoid air valve output	24 V, (150 mA)
Status output relay (ON/OFF)	Changeover contact (250 V, 1 A)
Operating temperature	0...+45 °C
Storage temperature	-10...+80 °C
Recommended fuse	3 A, 8 A, 16 A slow-blowing, Type 'D' MCB

Display and controls

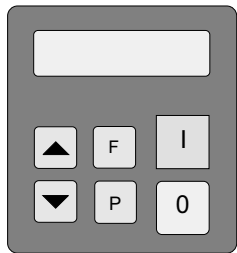

- Increase value
- Decrease value
- Return
- Programming mode or Enter
- Controller Output ON
- Controller Output OFF

**Instructions:**

Menus are used for changing settings. The different parameters are selected by entering a code.

All adjustments are made by first pressing the P key, followed by selecting the menu code, using the cursor keys.

**Settings**

Pressing the cursor key for a short time causes one digit increase/decrease, holding down for a longer time gives changes in ten-digit steps.

Changed settings are saved when exiting the menu or automatically if a key is not pressed for 60 seconds.

**Operating displays**

- Enable OFF
- Track full
- Setpoint in %
- Timer running
- Stop using "0" key

Settings	Range	Code	Factory settings	Menu code	Error messages
Amplitude (feed rate)	0... 100 %	A.	0 %	000, 008	
Maximum output voltage	5...100 %	P	90 %.	096, 008	Overload (output current too high).
Vibrating frequency	5...300 Hz	F.	100 Hz	096, 008	Possible cause: Feeder too large, frequency too low for installed coils, air gap too large.
Soft start ramp up	0... 60 sec.	/.	0.1 sec.	096	
Soft stop ramp down	0... 60 sec.	\.	0.1 sec.	096	
External setpoint	0 / 1	E.S.P.	0	003	Short-circuited output
Potentiometer setpoint	0 / 1	POT.	0	003	Possible cause: Incorrect wiring, possibly a defective coil.
Setpoint 0(4)... 20 mA	0 / 1	4.20	0	003	
Coarse / Fine control	0 / 1	2.SP.	0	003	
Invert enable	0 / 1	-En.	0	003	Input voltage too high
Switch on time delay	0... 60 sec.	l.	1.0 sec.	007, 167	Cause: Mains voltage too high or induced voltage from coil
Switch off time delay	0... 60 sec.	0.	1.0 sec.	007, 167	
Invert sensor	PNP/PNP invers	-SE.	PNP	007, 167	
Activate sensor timeout	0 / 1	E.En.	0	015	Sensor timeout has elapsed (material sensor)
Sensor timeout delay	1... 240 sec.	E.	180 sec.	015	
Switch off time air valve	0...60 sec.	Ai.	4 sec.	015	
Activate control mode	0 / 1	ACC.	0	008	Sensor fault (only in regulation mode)
P characteristic	0...100	P.A.	40	008	Accelerometer missing or faulty
I characteristic	0...100	I.A.	100	008	
Automatic frequency control ON	0 / 1	A.F.C.	0	008	
Automatic frequency search ON	0 / 1	A.F.S.	0	008	Current spike limit
Display output current		i.		040	Frequency set too low for installed coil or frequency altered too rapidly during setting up
Display output frequency		F.		040	
Pulse feed	0 / 1	HOP.	0	064	
On time delay (only if HOP = 1)	0..60 sec.	H.	1.0 sec.	064	
Off time delay (only if HOP = 1)	0..60 sec.	h.	1.0 sec.	064	
Invert Hopper sensor (not active)	0 / 1	-Ho.	0	064	
Save user settings	0...3	PUSH.	0	143	
Restore factory settings		FAC.		210	
Restore user settings	0...3	US.PA.	0	210	
Hide programming menus	0 / 1	Hd.C.	0	117	
Hide setpoint adjustment	0 / 1	di.S.	0	137	
Display software version				001	

**Error messages must be cleared in Menu no. C 009 by means of 'Cl.err.'**

**Timeout can be cleared with the 'I' key or by means of enable**

**Frequently appearing Errors, which are not described in this chapter, should be reported to the manufacturer.**

No code number is required to change the feed rate: pressing the P key twice will call the setpoint display.

Code 000 Feed rate set point		Feed rate setting

## Safety instructions

This description contains the necessary information for the correct application of the product described below. It is intended for use by technically qualified personnel. Qualified personnel are persons who, because of their training, experience and position, as well as their knowledge of appropriate standards, regulations, health and safety requirements and working conditions, are authorised to be responsible for the safety of the equipment, at all times, whilst carrying out their normal duties and are therefore aware of, and can report possible hazards (definition of qualified employees according to IEC 364).

### **WARNING!**

#### **Hazardous voltage!**

Failure to observe can kill, cause serious injury or damage.

Isolate from mains before installation or dismantling work, as well as for fuse changes or post installation modifications.

Observe the prescribed accident prevention and safety rules for the specific application.

Before putting into operation, check if the rated voltage for the unit conforms with the local supply voltage.

Emergency stop devices must be provided for all applications. Operation of the emergency stop must inhibit any further uncontrolled operation.

Electrical connections must be covered.

Earth connections must be checked for correct function, after installation.

### **Declaration of conformity**

We declare that these products conform with the following standards and directives:  
EN 50081-2 and EN 50082-2 in accordance with directive 89/336/EEC.

REO ELEKTRONIK AG, D-42657 Solingen

### **Specified use**

The units described herein are electrical controllers for installation in industrial plants. They are designed for power adjustment on vibratory feed equipment.

## Installation

Do supply voltage, operating voltage of the conveyor and controller input voltage match ?

Is the controller adequately rated for the rated power of the feeder ?

What is the vibrating frequency of the feeder ?

During switch-on, internal capacitors cause a high inrush current. Especially if several controllers are switched on simultaneously, the external fuse can blow or the circuit breaker can trip. Therefore, we recommend fitting slow-acting fuses or circuit breakers, e.g. with type 'D' characteristic.

Connect the unit in accordance with the wiring instructions and ensure that earthing is correct !

### **Attention!**

New units are factory set (see table with settings).

For units with unknown settings, first recall the factory settings using Menu C 210 'FAC'.

If an external setpoint source is used, select "E.S.P." = I in Menu C003. If a potentiometer is used, select also 'Pot.' = I.

To set the minimum vibration level, select E.S.P. = 0, adjust the vibration level with the cursor keys and then set E.S.P. = I.

The specific settings for a system can be saved by selecting 'US.PA.' in Menu C143 (recall settings via Menu C 210 'US.PA').

Menu access can be hidden by selecting 'Hd.C.' = I in Menu C117.

## Code 003 Function settings



0 = Setpoint using display  
1 = external setpoint 0...+10 V ON

0 = external setpoint 0...+10 V  
1 = external setpoint 4...20 mA

0 = 0...10 V / 0(4)...20 mA  
1 = Potentiometer

0 = Track control via backlog sensor  
1 = Coarse/fine control with second setpoint

0 = Enable  
1 = Invert enable

Operating mode

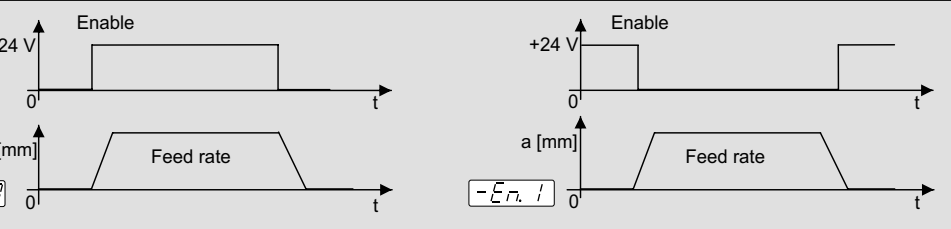
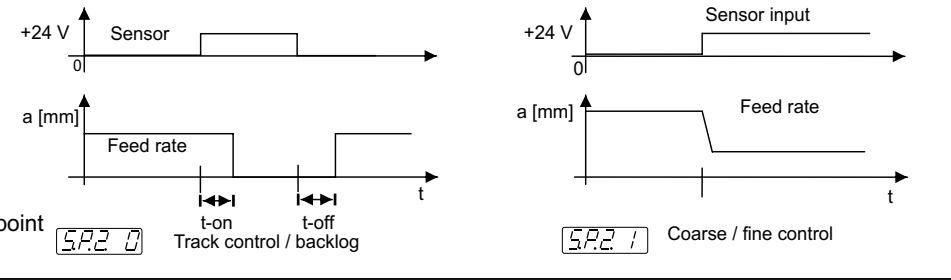
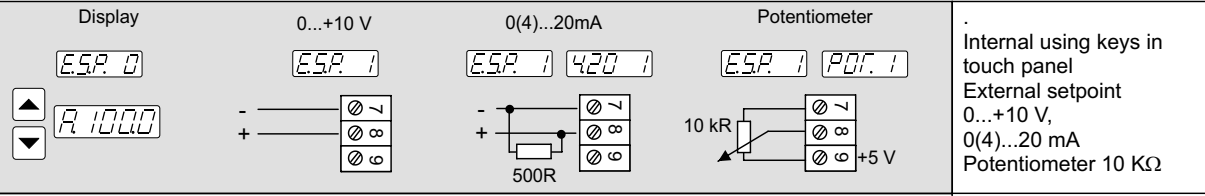

Internal using keys in touch panel  
External setpoint  
0...+10 V,  
0(4)...20 mA  
Potentiometer 10 KΩ

Track control  
or  
Coarse / fine control with  
two feed rates

+24 V signal or  
closed contact will  
enable the output.  
  
+24 V signal or  
closed contact will  
inhibit the output.

Set point input

Sensor input

Enable input

## Code 096 / 020 Feeder



Feed rate 0...100 %

Maximum limit 100...5 %

Vibrating frequency [Hz]

Soft start time 0...5 sec.

Soft stop time 0...5 sec.

Operating mode

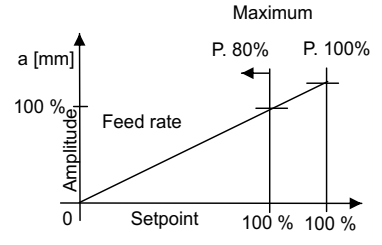
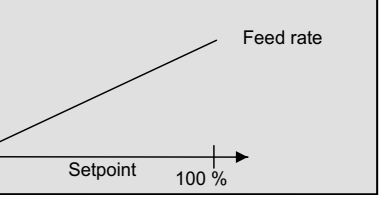

Limiting the maximum  
feed rate

The set point will still  
display 0... 100 %, even  
though it is limited  
internally.

Maximum feed rate

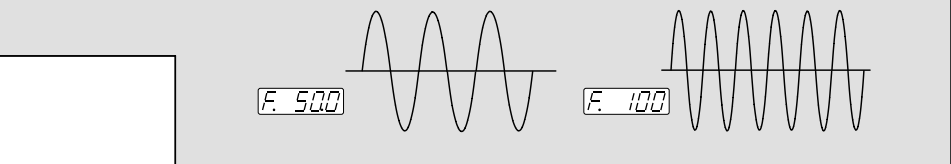

The frequency setting  
depends on the feeder  
type.  
**Important!**  
**The wrong frequency  
setting can damage the  
coil.**

Vibrating frequency

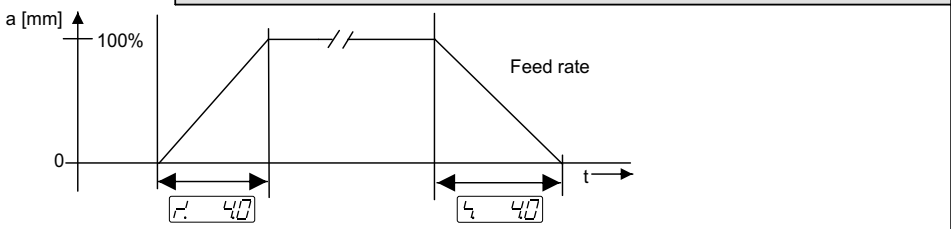

Time ramp for starting  
and stopping the feeder.

Soft start / soft stop

Maximum feed rate

Vibrating frequency

Soft start / soft stop

## Code 008 Control mode

C 008 P	R 100 P	Feed rate 0...100 %			Limiting of output voltage or feed rate, e.g. to prevent hammering. The displayed setpoint range remains at 0...100%.
P 1000 P	F 480 P	Maximum limit 100...5 % Vibrating frequency [Hz]			Frequency setting depends upon the feeder type.
ACC 1 P	PR 10 P	Switch to control mode 0 = Regulation (without sensor) 1 = Control (with sensor) Proportional characteristic (gain)			Activates the control mode to ensure a constant vibration amplitude, even with large load variations. The control mode requires an acceleration sensor.
IR 10 P	P	Integral characteristic (damping) Automatic frequency control 0 = Off 1 = On			Influences the regulation behaviour: Lineout time and vibration behaviour (pumping) of feeder.
Operating mode	AFC 0	f = fixed	AFC 1	f = f resonant	Automatic frequency change in case of resonance.
▲ key will start automatic frequency search					Start automatic frequency search

\* An acceleration sensor, type SW-70, has to be fitted to the feeder for constant amplitude control. Care must be taken in the method of mounting to ensure that the fixtures are solid, provide the correct orientation and do not flex under vibration.

### Manual setting of the vibrating frequency:

It is important to have a low set point setting (e.g. 30 %) because upon reaching resonance it is possible that a high amplitude will be induced, even with a low output voltage, thus increasing the risk of the coil "hammering". To determine the resonant frequency you must connect to the output. Resonant frequency has been reached when there is maximum amplitude and minimum output current.

### Automatic frequency search (regulation mode only).

\* Put set point at zero.

\* Select regulation mode ( Menu C 008, Parameter ACC = I ).

\* The optimum, vibrating frequency of the feeder is determined by initiating the frequency search (Menu C 008, Parameter, select A.F.S. and press any cursor key). Return the controller back to normal running mode after the resonant frequency has been found.

Code C 007 / C 167 Track control / Backlog sensor

▲ C 167 P

▲ 1 00 P

Switch on time delay  
0...60 sec.

▲ 0 00 P

Switch off time delay  
0...60 sec.

▲ -5E 1 P

Invert sensor function  
1 = inverted

Operating mode

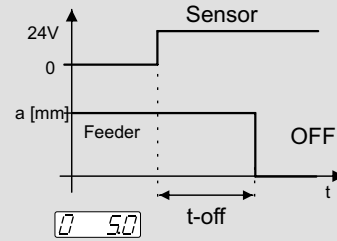
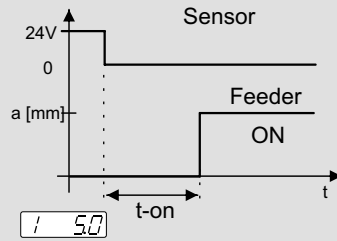

Adjustment of the ON and OFF delays

Time delays

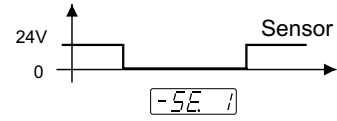
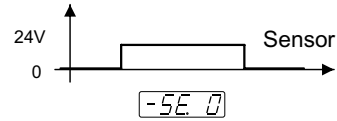

Invert sensor input

Sensor

Code 015 Special functions

▲ C 015 P

▲ EE n 1 P

0 = Feeder doesn't switch off during timeout  
1 = Feeder switches off during timeout

EE n 0 inactive  
EE n 1 active

▲ E 40 P

E. = Sensor timeout [sec]

▲ R. 10 P

Run-on-time for air valve output

Operating mode

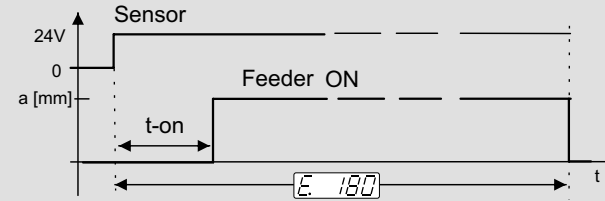

Sensor control active.  
If no components are detected during the timeout period, the feeder switches off.

Sensor control

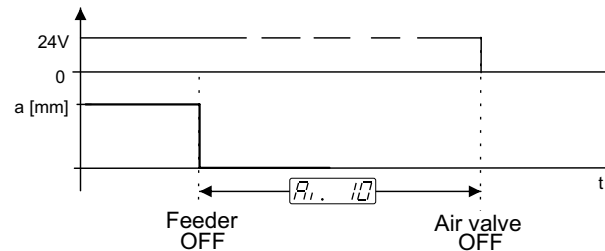

Setting the run-on-time for the air valve output.

Air valve output

Code 064 Pulse feed

▲ C 064 P

▲ HOP 1 P

0 = Pulse feed Off  
1 = Pulse feed On

▲ H 500 P

Feeder on time

▲ h 3 15 P

Feeder off time

▲ -H0 1 P

Sensor invert (not active)

Operating mode

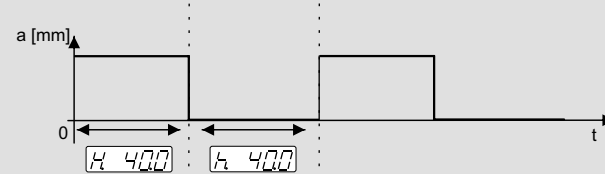

On and Off time for Hopper pulse feed

Pulse feed

**Code 117 Inhibit access**



I = Hidden menus



Parameter menus cannot be accessed, except for the feed rate setpoint

Hide programming menus.



Parameter menus can be accessed

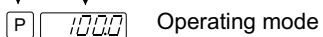

**Code 137 Inhibit setpoint access**



0 = Setpoint access ON  
I = Setpoint access OFF



Setpoint can be adjusted

Setpoint access



Setpoint cannot be adjusted

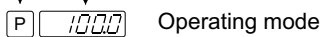

**Code 143 Save parameter settings**



Select parameters 0 to 3

Saves up to 4 different parameters (no. 0 - 3).

Save parameter settings



Save parameter settings

▲ All previously set parameters are saved.



**Code 210 Restore parameters**



Restore factory settings

▲ Restore factory settings.

Restore factory settings



Select parameters 0 to 3

Saves up to 4 different parameters (no. 0 - 3).

Restore parameter settings previously stored under C143



Restore user settings

▲ Restore settings saved under C143.



### Code 127 Enable service menu

<p> </p> <p>             P C.000   C.127 P              P ERS.0   ERS.1 P              P 1000 Service mode           </p> <p>             0 = Service mode OFF              1 = Service mode ON           </p>	<p> </p> <p>Enables access to the adjustment of I<sub>max</sub>, F<sub>min</sub> / F<sub>max</sub>, and Output voltage limiting.</p>	<p>Extended settings</p>	<p>Service</p>
--	--	--------------------------	----------------

### Code 040 Service

<p> </p> <p>             P C.000   C.040 P              P I.385 P           </p> <p>Actual value in % (display only) of the nominal coil current</p>	<p> </p> <p>Display shows the actual coil current in % of the nominal current (I<sub>nom</sub>).</p> <p>Conversion</p> $\frac{\text{Display} \times I_{\text{nom}}}{100} = \frac{38,5 \times 6}{100} = 2,31 \text{ A}$ <p>Monitoring the output current.</p>		
<p> </p> <p>             P I.1000   I.800 P           </p> <p>Current limit in % of I<sub>max</sub>.</p>	<p> </p> <p>Adjustment of the current limit in &amp; of the nominal current (I<sub>nom</sub>).</p> <p>Conversion: e.g. 4,8 A coil:</p> $\frac{\text{I-limit} \times 100}{I_{\text{nom}}} = \frac{4,8 \times 100}{6} = 80 \%$ <p>Adjusting output current limit depending on coil.</p>	<p>Current limit</p>	<p>Current limit</p>
<p> </p> <p>             P FL.35   FL.30 P           </p> <p>Lower frequency limit</p>			
<p> </p> <p>             P FH.120   FH.80 P           </p> <p>Upper frequency limit</p>			
<p> </p> <p>             P F.505 P           </p> <p>Actual frequency value (display only)</p>	<p>Adjustable frequency range Parameters 'F.L.' and 'F.H.' in Menu C 040.</p> <p>Effective frequency range Parameter 'F' in Menus C 008, C 096, and C 020.</p>	<p>Setting the limits of the frequency adjustment range accessible for the user. A narrow adjustment range is preferable for the automatic frequency search function.</p>	<p>Frequency range</p>
<p> </p> <p>             P PLI.0   PLI.1 P           </p> <p>Output voltage limiting 100 V 0 = Off, 1 = On</p>			
<p> </p> <p>             P 1000 P           </p> <p>Operating mode</p>	<p> </p> <p>Display shows the actual vibration frequency.</p> <p> </p> <p>When operated with 230 / 240 V mains supply, the output voltage is limited to 100 V.</p>	<p>Monitoring the vibration frequency</p>	



# MFS 268, 621605, 3Amp, IP 20

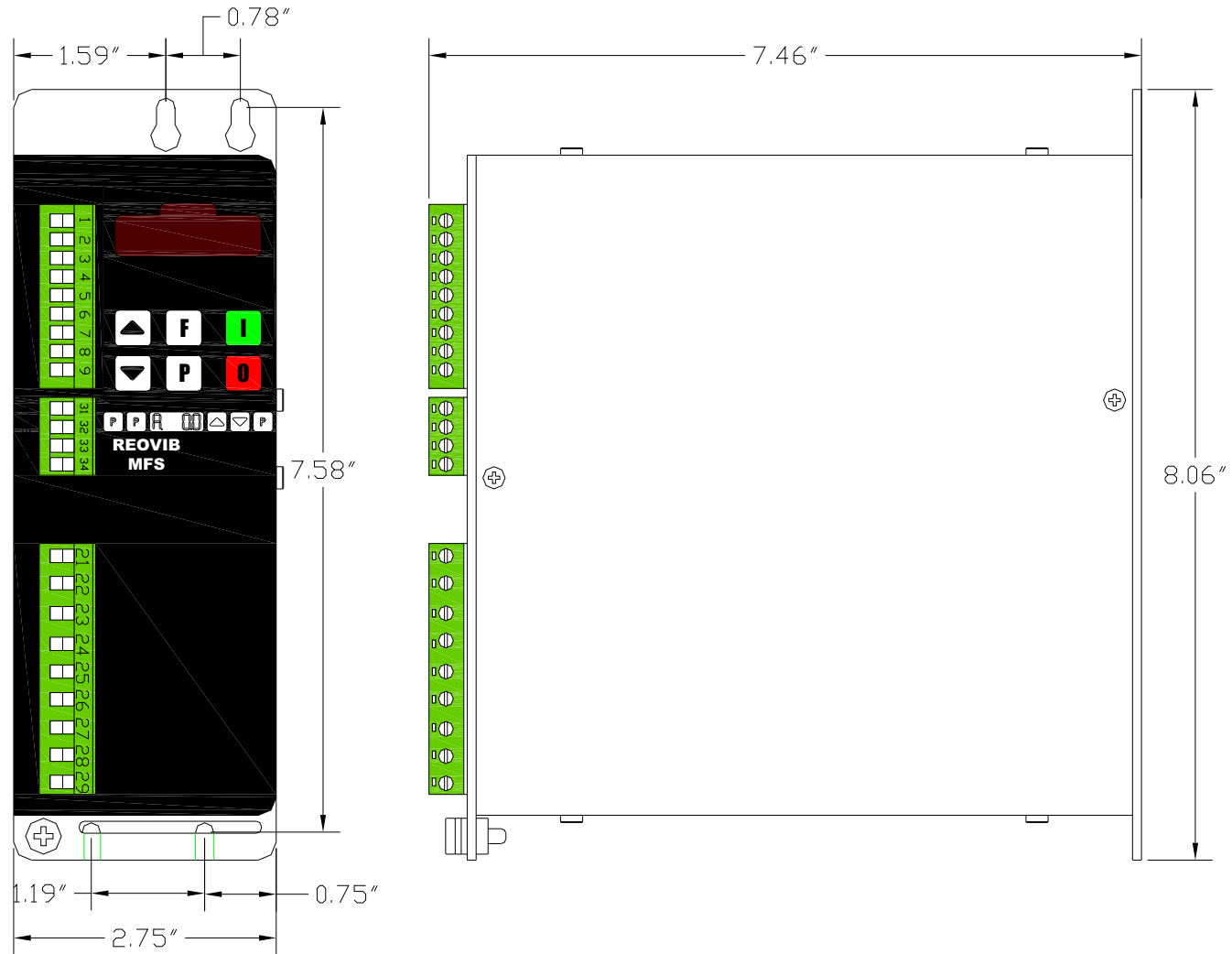

# MFS 268, 626848, 8Amp, IP 20

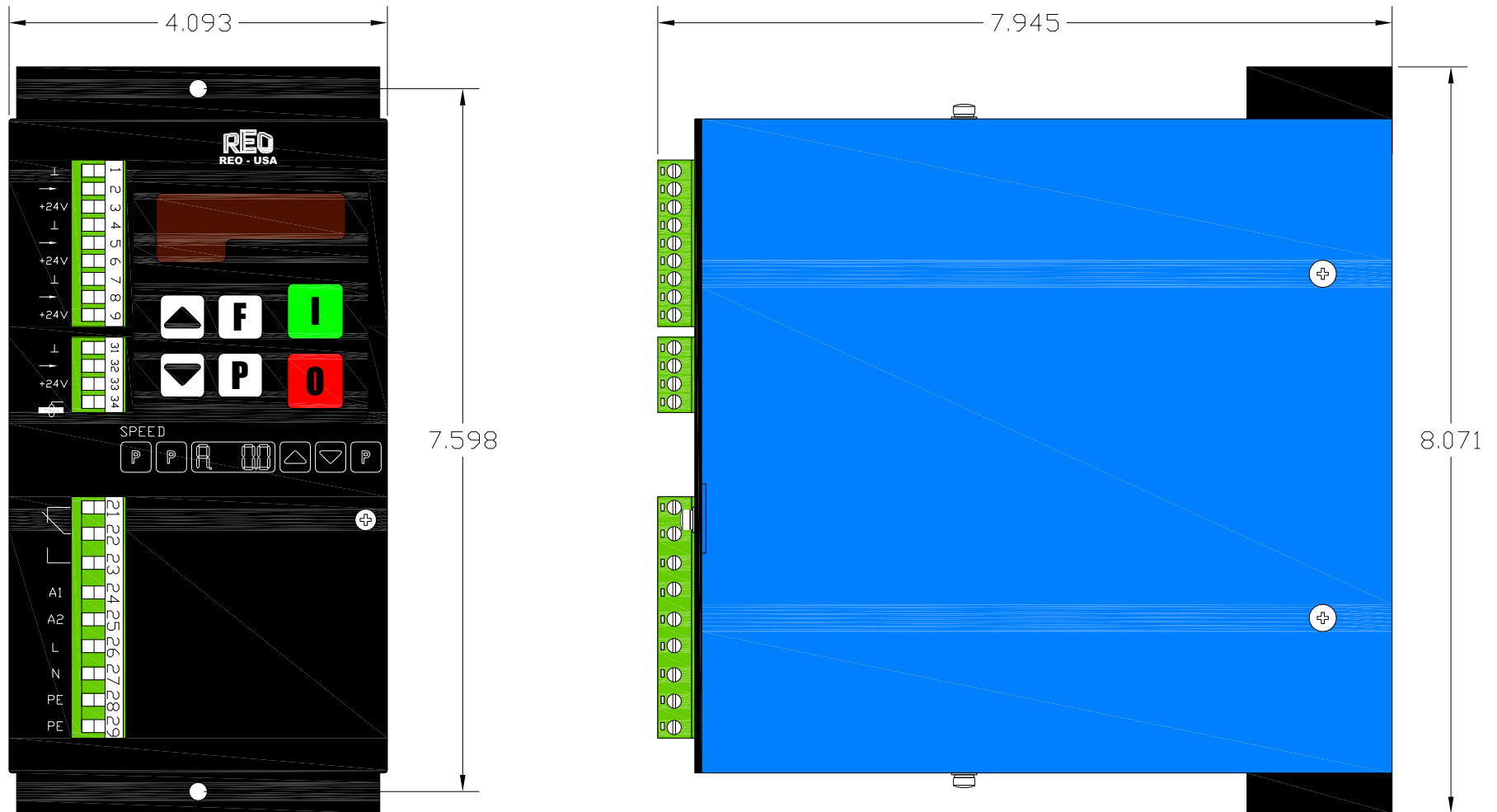

# MFS 268, 621103, 15Amp, IP 20

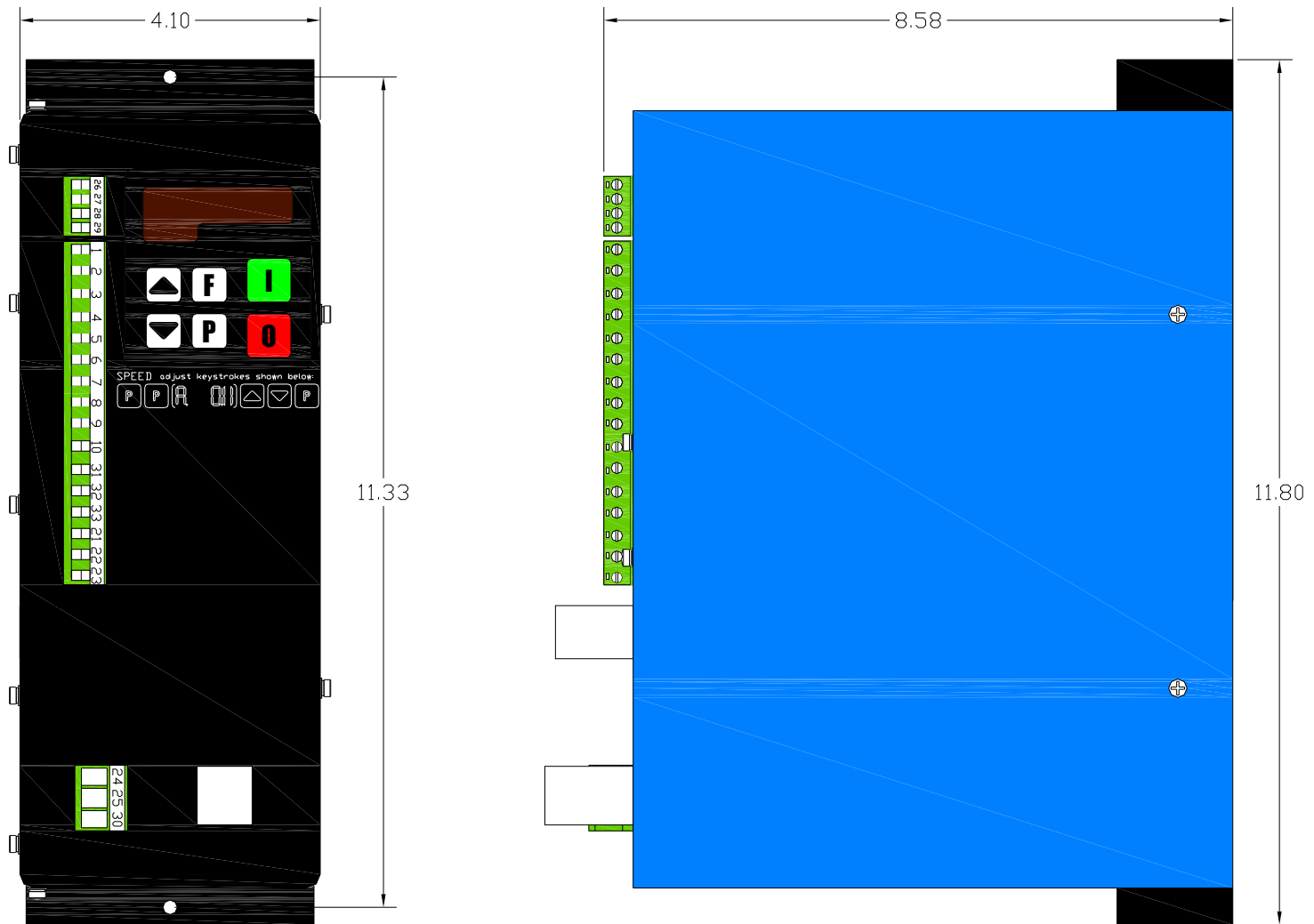

# MFS 268, 3Amp & 8Amp, IP 20, Electrical

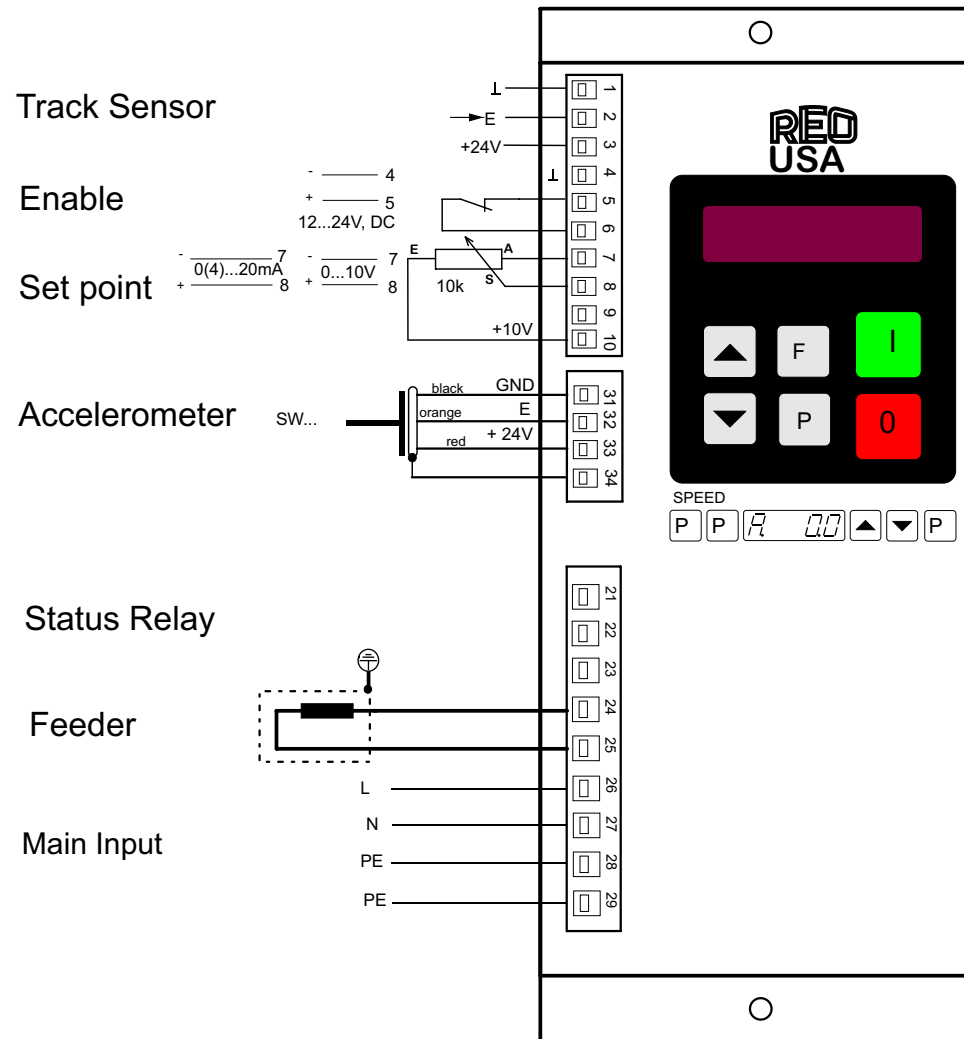

# MFS 268, 15Amp, IP 20, Electrical

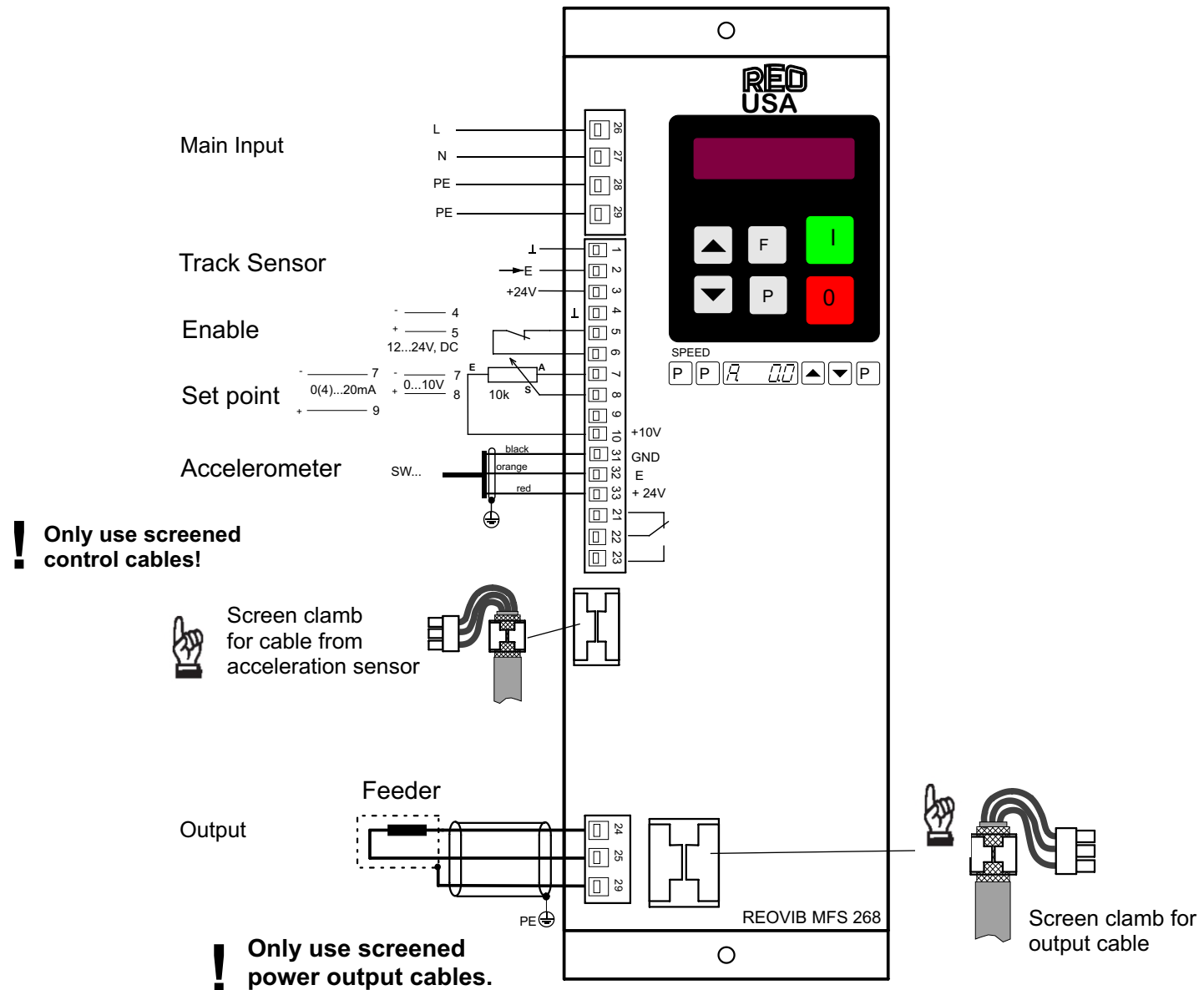

# MFS 268, 626848, 8Amp, IP 54

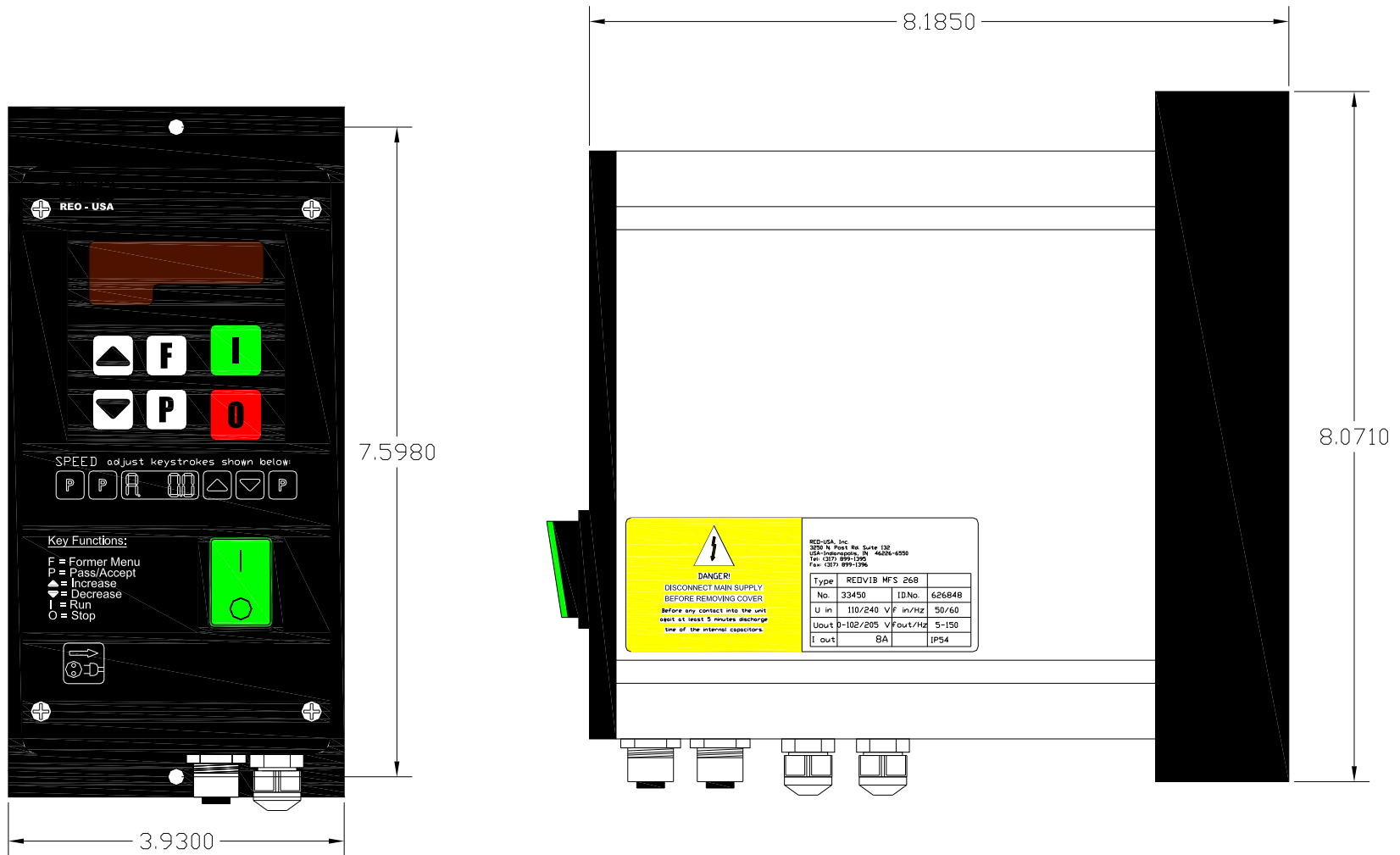

# MFS 268, 626867, 12Amp, IP 54

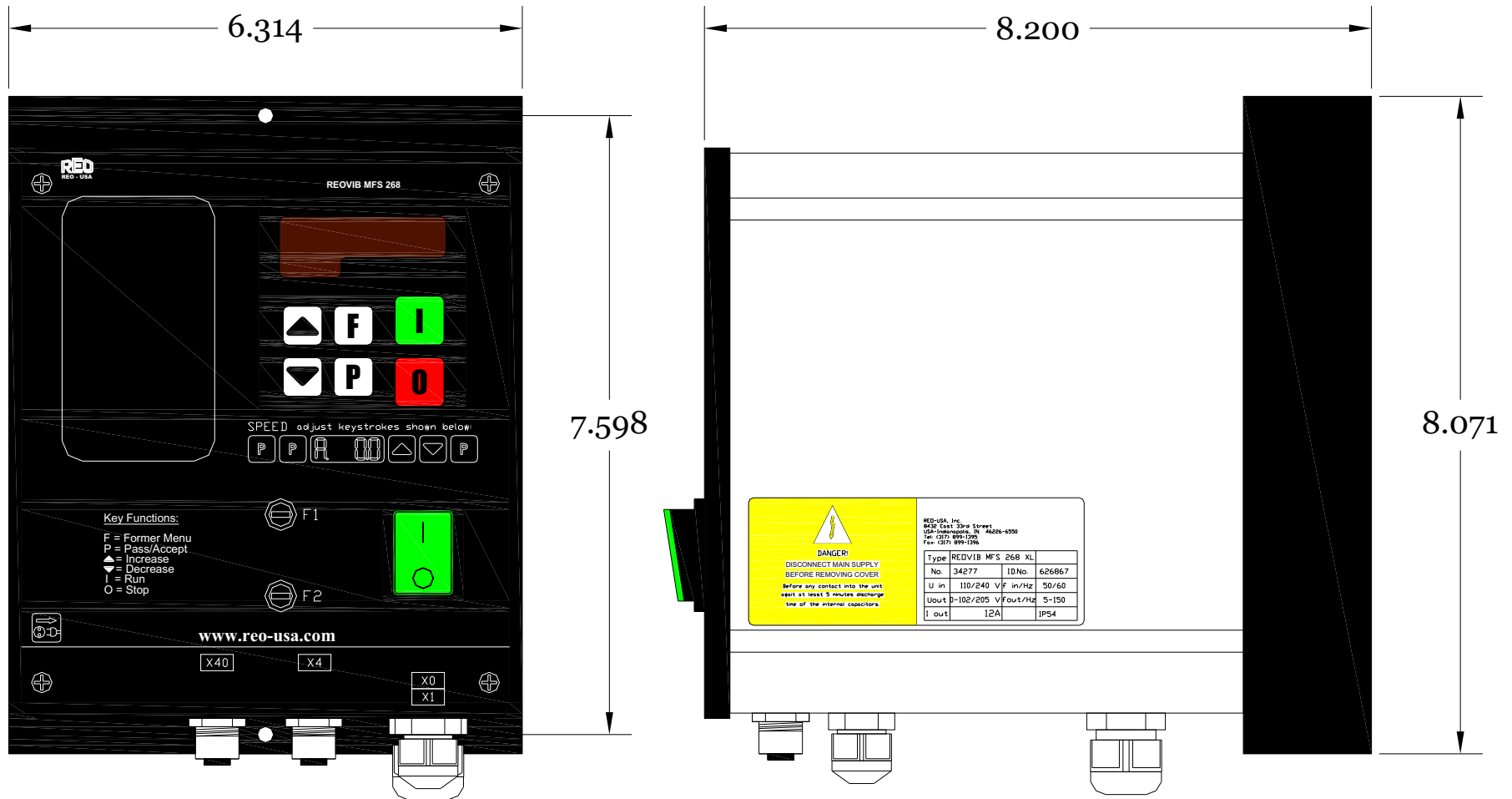

# MFS 268, 626887, 16Amp, IP 54

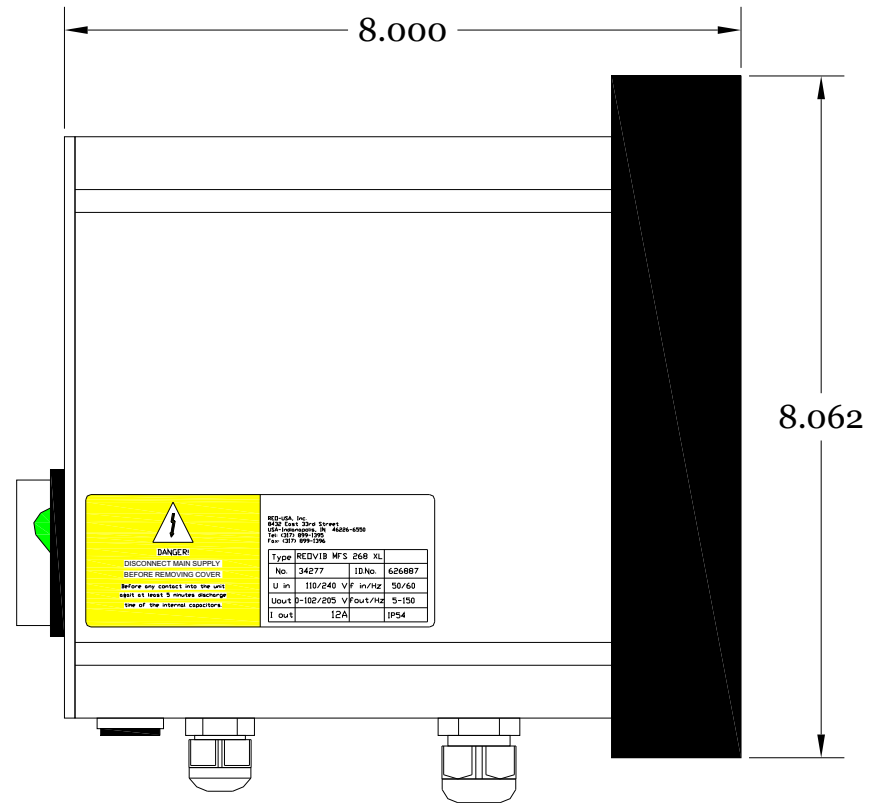
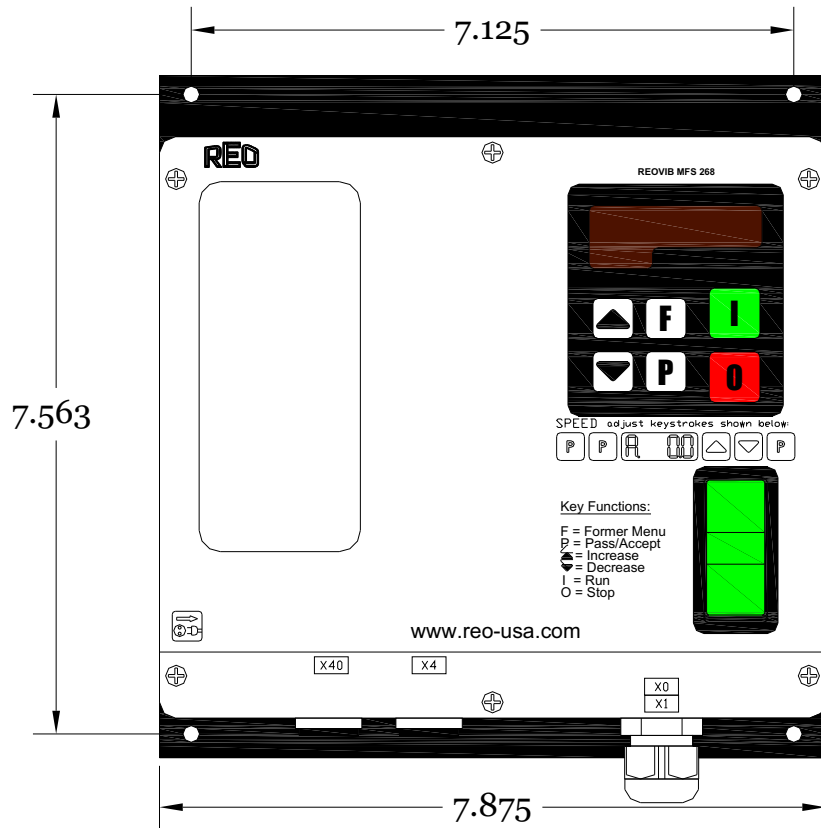



# MFS 268, IP 54, 8A, Electrical

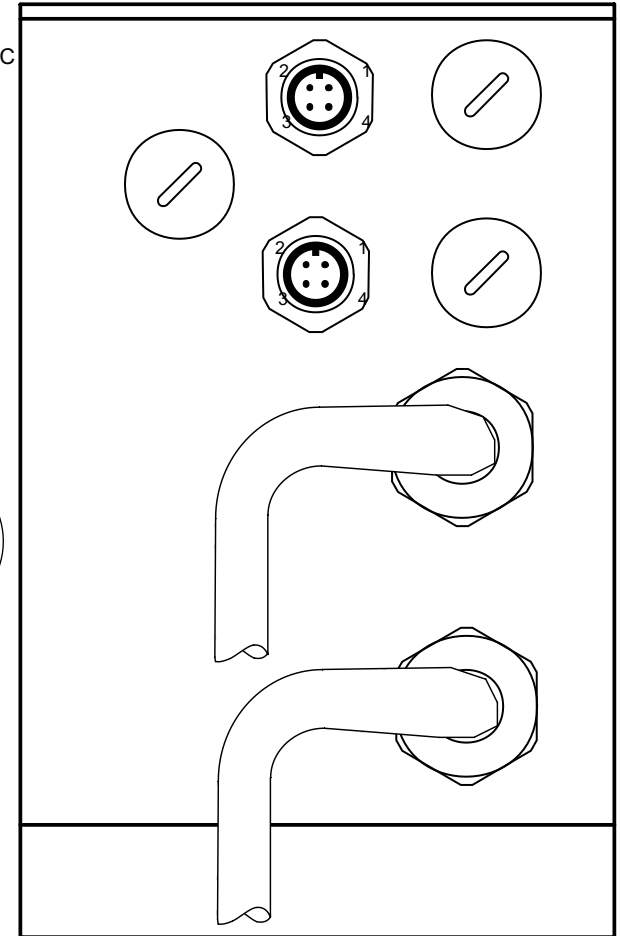
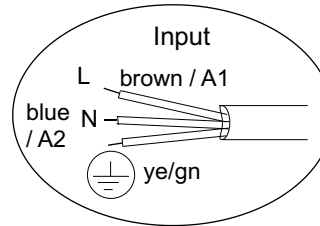
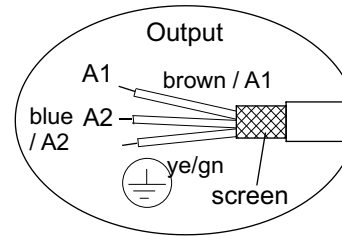
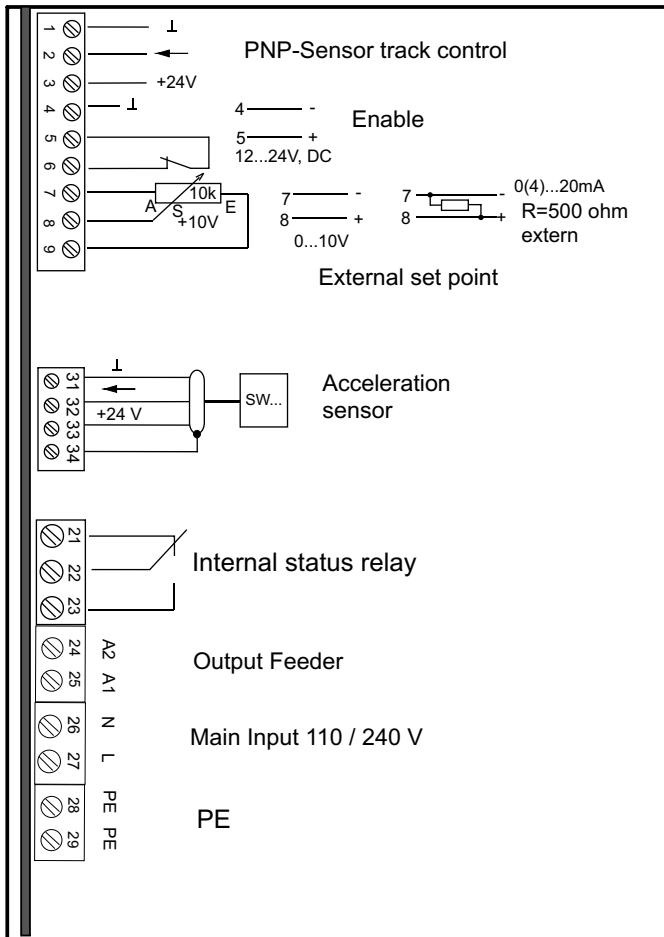

# MFS 268, IP 54, 12A & 16A, Electrical

